

DMX
DALI
TOUCH
CONTROL
0-10V
REGULADORES
DIMMER
ALIMENTADORES
DRIVER CC
PRO-LED
PERFILES
KNX

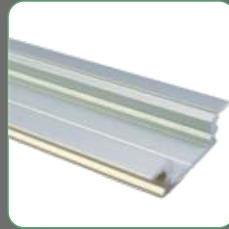

VISOLO

INFORMACIÓN TÉCNICA

La información técnica de este catálogo es correcta al momento de la impresión.

Visolo no se responsabiliza de los errores que pudiera tener este catálogo.

Todos los derechos reservados. No permitida la copia o difusión de toda la información contenida en este catálogo.

The technical information in this catalogue is correct at the time of printing.

Visolo is not responsible for any errors this catalog may have.

All rights reserved. Not permitted copying or dissemination of any information contained in this catalog.

MODIFICACIÓN

Reservado el derecho a cambios sin previo aviso.

Subject to change without notice.

FOTOS Y ESQUEMAS

Fotos y esquemas en este catálogo son ejemplos y no vinculante para el producto final en la entrega.

Photos and diagrams in this catalog are examples and no binding for the final product at delivery.

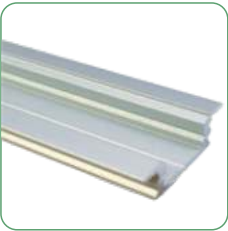
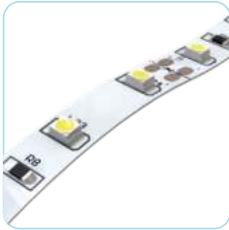

CONTROL

REGULADORES

ALIMENTADORES

TIRAS LED

PERFILES

APLIQUES

LÁMPARAS

EXTERIOR

ESQUEMAS

LED DE POTENCIA

Un led (del acrónimo inglés LED, light-emitting diode: 'diodo emisor de luz') es un componente optoelectrónico activo y, más concretamente, un diodo que emite luz. Normalmente esta luz es monocromática (color muy puro) y su color depende de la composición química del LED.

Ventajas.

Los LEDs presentan muchas ventajas sobre las fuentes de luz incandescente y fluorescente, tales como el bajo consumo de energía, un mayor tiempo de vida, tamaño reducido, resistencia a las vibraciones, reducida emisión de calor, no contienen mercurio, en comparación con la tecnología fluorescente, no crean campos magnéticos altos, no les afecta el encendido intermitente (es decir pueden funcionar como luces estroboscópicas) y esto no reduce su vida promedio, y en la mayoría de los colores cuentan con un alto nivel de fiabilidad y duración.

Funcionamiento.

Cuando un led se encuentra en polarización directa, los electrones pueden recombinarse con los huecos en el dispositivo, liberando energía en forma de fotones. Este efecto es llamado electroluminiscencia y el color de la luz (correspondiente a la energía del fotón) se determina a partir de la banda de energía del semiconductor. Por lo general, el área de un led es muy pequeña (menor a 1 mm²), y se pueden usar componentes ópticos integrados para formar su patrón de radiación.

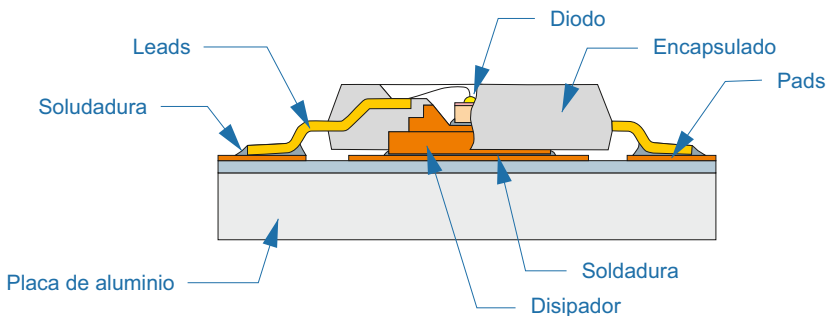

Aplicaciones.

Los leds en la actualidad se pueden acondicionar o incorporarse en un porcentaje mayor al 90 % a todas las tecnologías de iluminación actuales.

El mercado del LED empieza a ser muy denso y confuso, miles de productos aparentemente iguales se despliegan ante nosotros y no sabemos muy bien sus diferencias y ventajas.

En Visolo fabricamos luminarias básicamente con 3 tipos de LED diferentes:

LED SMD

LED COB

LED SMD DE POTENCIA (POWER LED)

La principal diferencia entre estos 3 tipos de LED es su construcción y la forma que están diseñados para disipar el calor. La gestión térmica de las luminarias es esencial para garantizar la duración y el correcto funcionamiento de una luminaria LED.



Los LED SMD son los de menor tamaño y obtienen un rendimiento lumínico de 60-70LM/W, la mitad que los LED COB y POWER LEDs.



Los LED COB están contruidos como una matriz de LED's, es decir una concentración de LEDs en una pastilla recubierta de silicona. Gracias a tener insertados multitud de LEDs en un mismo encapsulado tienen una gestión del calor mucho mejor que las luminarias LED SMD.



Los POWER LEDs tienen potencias muy superiores a un LED SMD convencional y requieren ser instalados en placas de aluminio con los que disipar el calor generado por estos. Su rendimiento lumínico y durabilidad son excelentes y son este tipo los que se instalan hoy en día en cualquier luminaria profesional de alto rendimiento.

PROTOS

Los sistemas de control de iluminación son una herramienta de diseño que además de reducir el consumo energético, permite a los usuarios personalizar sus espacios y crear ambientes confortables mediante la regulación de las luminarias, el ajuste y programación de escenas de luz, incluso la gestión a nivel cronológico. El tipo del sistema elegido dependerá en buena medida del tamaño de la instalación, los requerimientos del cliente y el presupuesto. Aunque existe una amplia oferta de protocolos ofrecidos por diversos fabricantes, en esta nota presentamos tres de los sistemas de control más utilizados por su facilidad de programación y compatibilidad entre marcas y equipos:

0-10V

El método de **control 0-10V** es uno de los más sencillos. Se trata de la variación en la corriente continua que permite la regulación del flujo lumínico entre el 1 y el 100%, a través de una señal analógica. De este modo, la iluminación controlada escala su salida, siendo 10V igual al 100% de la potencia lumínica y 0V la mínima luminosidad.

Este método permite la regulación del flujo lumínico, así como el encendido y apagado del equipo a través de un interruptor colocado en la línea de alimentación. Por tratarse de una herramienta analógica no es posible direccionarlo a través de softwares, por ello la creación de grupos se hace mediante cables.



DALI (Digital Addressable Lighting Interface) es un estándar bidireccional en el que la información corre desde un controlador hacia los equipos de iluminación que ejecutan las órdenes y solicitudes de información. Este sistema permite una adecuada gestión de la iluminación arquitectónica, incluso puede ser integrado en calidad de subsistema a los protocolos más actuales de control de edificios. Permite la creación de hasta 16 escenas diferentes y envía alertas de fallos en las luminarias. La comunicación de dichas señales digitales se realiza a través de una línea de control de dos hilos (bus), y una velocidad de transmisión de datos a 1,2 Kb/s. El sistema DALI posee una curva de regulación logarítmica ajustada a la sensibilidad del ojo humano, definida en la norma internacional IEC 62386, que también regula la compatibilidad entre balastos de diferentes marcas.

DMX

512

DMX (Digital Multiplex) es un protocolo utilizado principalmente para el control de iluminación en escenarios; para iluminación arquitectónica es muy común utilizarlo en fachadas multimedia. Este protocolo utiliza canales para la transmisión de órdenes a los equipos mediante cables de 3 o 5 pines, a una velocidad de transmisión de datos superior a los 250 Kb/s. DMX está limitado a 512 canales por universo. Cada canal DMX controla un parámetro o efecto específico. Por ejemplo, el canal DMX1 se puede asignar para controlar el nivel de intensidad lumínica y el DMX2 para dar un efecto de estrobo, al 3 se le asigna cambio de color, al DMX 4 movimiento horizontal, etc. Existen consolas profesionales que soportan hasta 8 universos con la opción de ampliarlos utilizando la tecnología EtherDMX.



KNX es el protocolo que se ha convertido en el estándar europeo domótico. Prácticamente la totalidad de las instalaciones domóticas e inmóticas que se realizan a día de hoy instalan el protocolo KNX. Realmente KNX es la abreviatura de EIB KONNEX y es un sistema descentralizado, es decir, no requiere de un controlador central de la instalación. En él, todos los dispositivos que se conectan al bus de comunicación de datos tienen su propio microprocesador y electrónica de acceso al medio. KNX está basado en el modelo OSI y es el sucesor de tres tecnologías: el European Home Systems Protocol (EHS), BatiBUS, y el European Installation Bus (EIB or Instabus) y a día de hoy presume de ser "el único ESTÁNDAR abierto para todas las aplicaciones de control de la vivienda y el edificio". Las instalaciones de tipo EIB KONNEX pueden abarcar más de 10.000 de estos dispositivos, por lo que son aplicables a todo tipo de edificaciones: viviendas, hospitales, hoteles, etc.

SIMBOLOGÍA



Indicador fundamental de la conformidad de los productos con la legislación de la UE.
Key indicator of product conformity with EU legislation.



Referencia a la norma internacional IEC60529 para calificar de una manera alfanumérica a equipamientos en función del nivel de protección que sus materiales contenedores le proporcionan contra la entrada de materiales extraños.

Reference to the international standard IEC60529 to qualify in an alphanumeric way equipment according to the level of protection that its container materials provide against the entry of foreign materials.



Materiales con los que ha sido fabricado un producto pueden ser reciclables.
Materials with which a product has been manufactured may be recyclable.



Indica la recogida selectiva de los aparatos eléctricos y electrónicos (AEE) una vez finalizada su vida útil para que entre en el circuito de reciclaje, y no acaben en contenedores de basura no autorizados.

It indicates the selective collection of electrical and electronic equipment (EEE) at the end of its useful life so that it enters the recycling circuit, and does not end up in unauthorized garbage containers.



Productos certificados para su uso en interior.
Products certified for indoor use.



Productos certificados para su instalación en muebles.
Products certified for installation in furniture.



Señal de voltaje de entrada de corriente alterna.
AC input voltage signal.



Señal de voltaje de entrada de corriente continua.
DC input voltage signal.



Número de canales de salida con los que cuenta el dispositivo.
Number of output channels that the device has.



Potencia máxima para el conjunto del producto.
Maximum power for the whole of the product.



Intensidad máxima para el conjunto del producto.
Maximum intensity for the whole product.



Producto con soporte para el protocolo DMX.
Product with support for DMX protocol.



Producto con soporte para radiofrecuencia.
Product with support for radiofrequency.



Indicador de la temperatura ambiente en la que el producto funciona de manera óptima.
Ambient temperature indicator in which the product works optimally.



Indicador del diámetro de recorte para productos empotrables.
Cutting diameter indicator for built-in products.

CTR-RGB-BOX

CTR-RGB-BOX/12
CTR-RGB-BOX/24

Convertidor DMX con entrada XLR-3R estandar.
Posibilidad en salida 12V y 24V.
6 salidas RGB con 50W por salida.
32 funciones.
L400xAn305xAl160(mm)



CONTROL

Doble fuente de alimentación incluida

Placa de control con 32 programas compatible con DMX con 6 direcciones independientes.

Entrada 220V AC

6 salidas RGB con 50W(max)



TP-D1

Controladores táctiles con potencia incorporada, conexión directa a los led.



Controlador táctil para montaje en paredes en hueco universal.
Control por dimmer con 4 canales con hasta 4A por canal.
Rango dimmer de 5% a 100%.
L86×An86×Al36(mm)

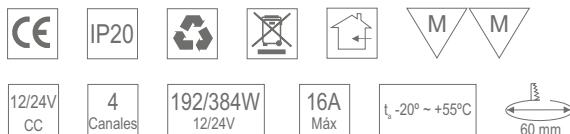

Ejemplo de instalación pág: 95

TP-D2



Controlador táctil para montaje en paredes en hueco universal.
Control de temperatura con 4 canales con hasta 4A por canal.
8 niveles de luminosidad con 3 modos CT y 2 escenas.
L86×An86×Al36(mm)

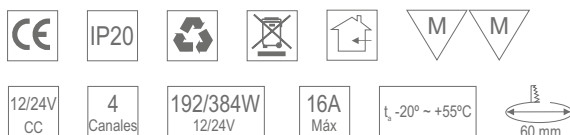

Ejemplo de instalación pág: 95

TP-D3



Controlador táctil para montaje en paredes en hueco universal.
Control RGB con 3 canales con hasta 4A por canal.
8 niveles de luminosidad y 2 escenas.
L86×An86×Al36(mm)

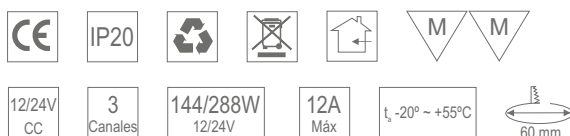

Ejemplo de instalación pág: 95

TP-D4



Controlador táctil para montaje en paredes en hueco universal.
Control RGB+W con 4 canales con hasta 4A por canal.
8 niveles de luminosidad, 1 escena y tecla directa al blanco.
L86×An86×Al36(mm)

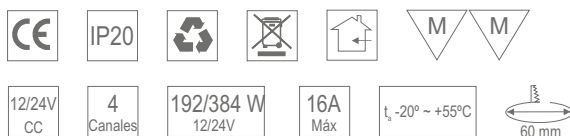

Ejemplo de instalación pág: 95

Controladores táctiles por cableado DMX o con receptores RF.

TP-5X

Controlador táctil para montaje en paredes en hueco universal. Control por dimmer mediante DMX512 con 4 zonas y 4 escenas. Receptores inalámbricos opcionales. Rango dimmer de 5% a 100%. L86×An86×Al36(mm)



Ejemplo de instalación pág: 96 (TP-8X)

TP-6X

Controlador táctil para montaje en paredes en hueco universal. Control de temperatura y dimmer por DMX512 con 4 zonas y 4 escenas. Receptores inalámbricos opcionales. Rango dimmer de 5% a 100%. L86×An86×Al36(mm)



Ejemplo de instalación pág: 96 (TP-8X)

TP-7X

Controlador táctil para montaje en paredes en hueco universal. Control de RGB por DMX512 con 4 zonas y 1 escena. Receptores inalámbricos opcionales. Rango dimmer de 5% a 100%. L86×An86×Al36(mm)



Ejemplo de instalación pág: 96 (TP-8X)

TP-8X

Controlador táctil para montaje en paredes en hueco universal. Control de RGB+W por DMX512 con 4 zonas. Receptores inalámbricos opcionales. Rango dimmer de 5% a 100%. L86×An86×Al36(mm)



Ejemplo de instalación pág: 96 (TP-8X)

MI-P2



Controlador táctil para montaje en paredes en hueco universal.
Control por dimmer+CTA* con 2 canales con hasta 5A por canal.
9 modos, tecla pagado 60secs, 2 memorias
L86×An86×Al30(mm)

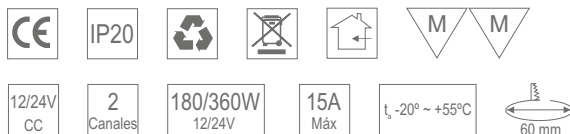

MI-P3



Controlador táctil para montaje en paredes en hueco universal.
Control smart RGB/RGBW/RGB+CTA* con hasta 5 canales.
12 modos, tecla apagado en 60sec, saturación blanco+color.
L86×An86×Al30(mm)

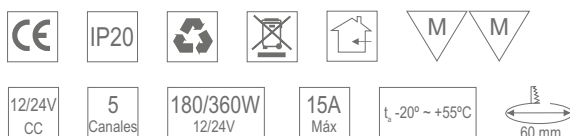

MI-FUTD01



Antena DMX con entrada XRL para controlar inalámbricamente
hasta 16 zonas de 5 canales por zona.
Para uso con el receptor MI-FUTD02 y la lámpara MI-FUTD03.
L188×An47×Al23(mm)



Ejemplo de instalación pág: 108

MI-FUTD02



Receptor inalámbrico DMX para antena MI-FUTD01
5 canales con hasta 6A por canal, máximo total 10A.
L85×An45×Al22.5(mm)

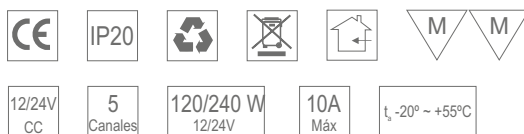

Ejemplo de instalación pág: 108

*Control de Temperatura Ajustable.

SLESA-U9

Controlador DMX programable hasta 256 canales.
1 zona con 20 escenas y hasta 218 pasos.
L92×An79×Al43(mm)
(Requiere un PC para su programación)

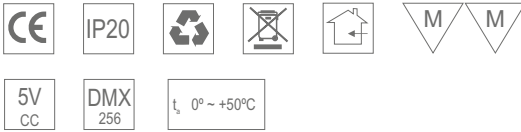

Ejemplo de instalación pág: 108



CONTROL

SLESA-UE7

Controlador DMX programable para 2 universos DMX512.
5 zonas con 250 escenas y pasos ilimitados.
L92×An79×Al43(mm)
(Requiere un PC para su programación)



Ejemplo de instalación pág: 97



STICK CU4

Controlador DMX táctil programable hasta 512 canales.
1 zona con 36 escenas y hasta 76000 pasos.
L146×An106×Al11(mm)
(Requiere un PC para su programación)



STICK DE3

Controlador DMX táctil programable para 2 universos DMX512.
10 zonas con 500 escenas y pasos ilimitados.
L146×An106×Al11(mm)
(Requiere un PC para su programación)



Ejemplo de instalación pág: 97



WDIMMER



Controlador para cambio RGB por DMX.
2 memorias y dimmer.
L84×An83×Al40(mm)

Solo funciona correctamente con el controlador HC100 (pág 12)



Ejemplo de instalación pág: 98

WDIMMER6

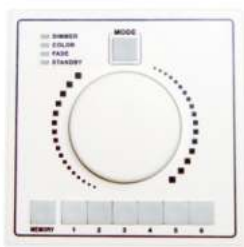

Controlador para cambio RGB por DMX.
6 memorias y dimmer.
6 zonas y 4 canales.
L87×An87×Al38(mm)



Ejemplo de instalación pág: 98

MI-RF2.1



Controlador por radiofrecuencia.
Control RGB+W con 4 canales con hasta 6A por canal.
Receptor: L85×An45×Al22.5(mm)
Mando: L110×An53×Al20.5(mm)

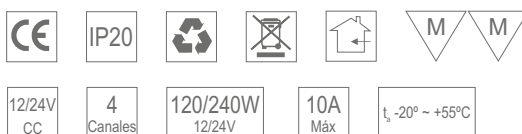

Ejemplo de instalación pág: 99

MI-BT2.4

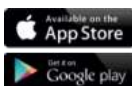

Controlador por bluetooth a dispositivos móviles Android y Apple.
Control RGB+CTA* con 5 canales con hasta 6A por canal.
La App puede controlar hasta 4 receptores.
L85×An45×Al22.5(mm)

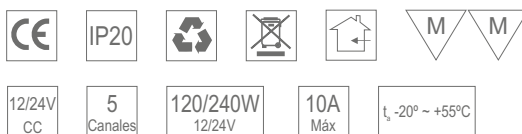

Ejemplo de instalación pág: 99

*Control de Temperatura Ajustable.

Controladores CTA por RF

Mando con 4 zonas RF con funciones CTA*.
Compatible con receptor MI-FUT035.
Compatible con lámparas MI-FUT011 y MI-FUT019.
L120×An52,5×Al21(mm)



Ejemplo de instalación pág: 107

MI-RFCTA



CONTROL

MI-T2

Panel táctil con 4 zonas RF con funciones CTA*.
Compatible con receptor MI-FUT035.
Compatible con lámparas MI-FUT011 y MI-FUT019.
L86×An86×Al36(mm)



Ejemplo de instalación pág: 107



MI-B2

Panel táctil con 4 zonas RF con funciones CTA*.
Compatible con receptor MI-FUT035.
Compatible con lámparas MI-FUT011 y MI-FUT019.
Fácil instalación, funciona con 2 pilas AAA como un mando remoto.
L86×An86×Al17(mm)

Funciona solo con 2 pilas AAA



Ejemplo de instalación pág: 107



MI-FUT035

Receptor/Controlador inalámbrico para CTA*.
2 canales con hasta 6A por canal, máximo total 10A.
L85×An45×Al22,5(mm)



Ejemplo de instalación pág: 107



*Control de Temperatura Ajustable.

MI-RFRGBCTA

Controladores RGB/RGBW/RGB+CTA por RF



Mando con 4 zonas RF con funciones RGB / RGBW / RGB+CTA*. Compatible con receptor MI-RF2.4R y MI-FUT039. Compatible con lámparas MI-FUT016 y MI-FUT018. L138×An56×Al38(mm)



Ejemplo de instalación pág: 107

MI-T4



Panel táctil con 4 zonas RF con funciones RGB / RGBW / RGB+CTA*. Compatible con receptor MI-RF2.4R y MI-FUT039. Compatible con lámparas MI-FUT016 y MI-FUT018. L86×An86×Al36(mm)



Ejemplo de instalación pág: 107

MI-B4



Funciona solo con 2 pilas AAA

Panel táctil con 4 zonas RF con funciones RGB / RGBW / RGB+CTA*. Compatible con receptor MI-RF2.4R y MI-FUT039. Compatible con lámparas MI-FUT016 y MI-FUT018. Fácil instalación, funciona con 2 pilas AAA como un mando remoto. L86×An86×Al20(mm)



Ejemplo de instalación pág: 107

MI-FUT039



Receptor/Controlador inalámbrico para RGB+CTA*. 5 canales con hasta 6A por canal, máximo total 10A. L85×An45×Al22.5(mm)



Ejemplo de instalación pág: 107

*Control de Temperatura Ajustable.

MI-FUT037

Receptor/Controlador inalámbrico para RGB.
3 canales con hasta 6A por canal, máximo total 10A.
L85×An45×Al22.5(mm)



Ejemplo de instalación pág: 107

CONTROL

MI-RF2.4

Mando con 4 zonas RF con funciones RGB / RGBW.
Compatible con receptor MI-RF2.4R.
Compatible con lámparas MI-FUTO16 y MI-FUTO18.
L120×An52.5×Al21(mm)



Ejemplo de instalación pág: 107

MI-RF2.4R

Receptor/Controlador inalámbrico para RGBW.
4 canales con hasta 6A por canal, máximo total 10A.
L85×An45×Al22.5(mm)



Ejemplo de instalación pág: 107

MI-IBOX

Puente WIFI para controlar con dispositivos móviles receptores y lámparas de la serie MI. Emula todos los mandos.
Función extra de encendido y apagado temporizado.
L90×An66×Al15(mm)



Ejemplo de instalación pág: 107

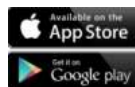

MI-IBOX



Puente WiFi para controlar con dispositivos móviles receptores y lámparas de la serie MI. Emula todos los mandos. Función extra de encendido y apagado temporizado. L90×An66×Al15(mm)



CONTROL

Ejemplo de instalación pág: 107

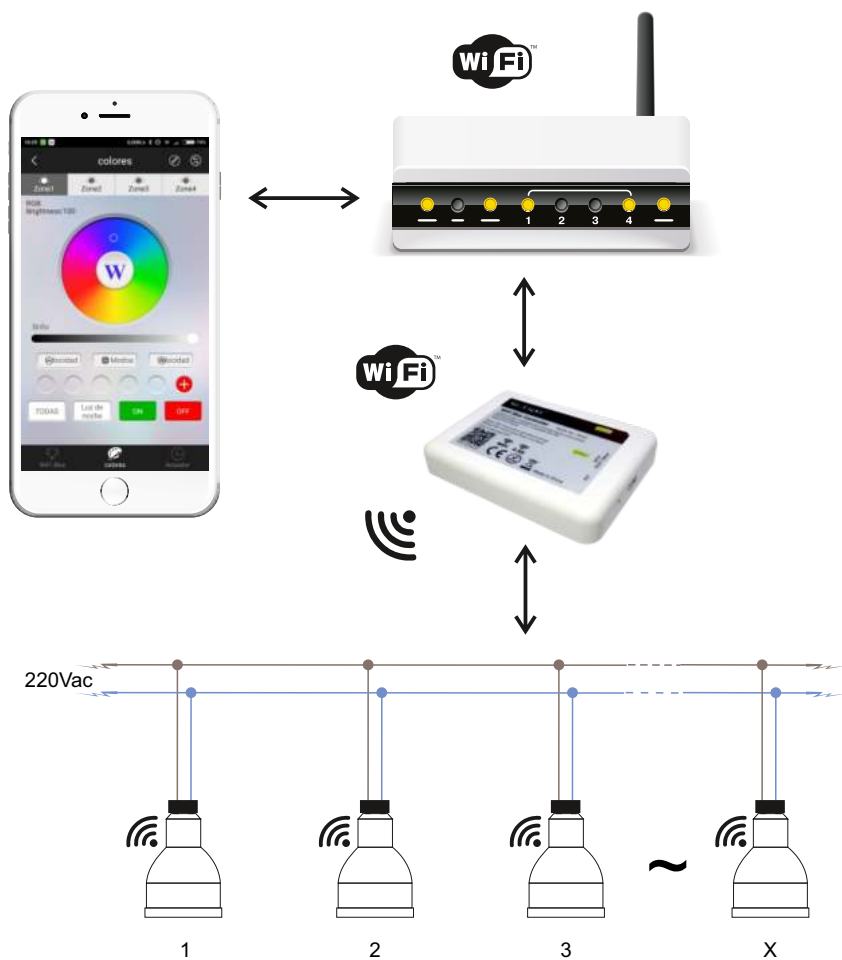

Consultar tabla de compatibilidad: pág 98

MI-IBOX

CONTROL

Compatible con todos los productos de la gama MI. Puede controlar la iluminación desde cualquier lugar. Programe la hora de encendido y apagado.



AVC-DALI1



Convertidor del protocolo DALI a PWM.
Controlable mediante protocolo DALI, por pulsador o 0..10V.
Entrada y salida de 10 a 24V.
L109×An69×Al28(mm)



Ejemplo de instalación pág: 105

HC100



Convertidor con entrada XRL.
Controlado por universo DMX 4 canales (RGB+Dimmer).
L193×An70×Al40(mm)



Ejemplo de instalación pág: 98

DMXPX24501

DMXPX24501/4



Convertidor DMX por voltaje con entrada XLR-3R estándar.
DMX PX24501: 3 canales RGB
DMX PX24501/4: 3 canales RGB + dimmer/strobo
L139×An82×Al42(mm)



Ejemplo de instalación pág: 97

DMXPXRGB+W



Convertidor DMX por voltaje con entrada XLR-3R estándar.
3 canales RGB con hasta 4A por canal y canal Blanco (12A).
L157×An65×Al40(mm)



Ejemplo de instalación pág: 97

DMXPX350 | DMXPX700

Convertidor DMX por corriente con entrada XLR-3R estandar.
 PX350: 3 canales RGB con 350mA por canal.
 PX700: 3 canales RGB con 700mA por canal.
 12V=1-3 led / 24V=1-6 led / 48V=1-12 led.
 L139×An82×Al42(mm)



Ejemplo de instalación pág: 97

TRGBox

Convertidor para mezcla de color RGB para LEDs de 1W.
 Min. 3LED, Máx. 27LED
 3 Canales con salida PWM.
 Opcional DMX y control remoto.
 L145×An75×Al29(mm)

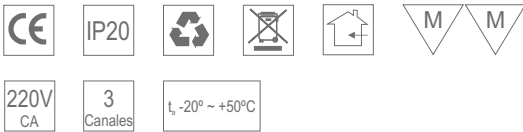

Ejemplo de instalación pág: 103

TRGBox4/12 | TRGBox4/24

Convertidor para mezcla de color RGBW de 12 y 24V.
 TRGBox4/12: 4 x 1,56A max 75W.
 TRGBox4/24: 4 x 1,04A max 100W.
 Control por pulsador, DALI y DMX integrado.
 L207×An76×Al35(mm)

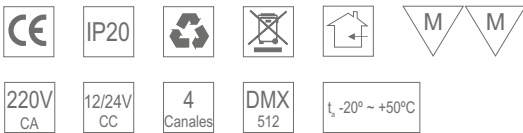

Ejemplo de instalación pág: 104

DMX-A4-SPLITTER

DMX-A6-SPLITTER

Splitter DMX con 4 o 6 salidas.
 L280 ×An150 ×Al70 (mm)



Ejemplo de instalación pág: 98

CONTROL

DIM6-IR



Dimmer LED con mando IR con salida de corriente constante.
2 Canales. Hasta 6 led.
Pueden añadirse amplifieds de CC y VC para aumentar la cantidad de leds controlables.
L87×An87×Al57(mm)

CE	IP20	Recycling	No Hazardous	Household	M M
12-24V CC	2 Canal	350 mA	t_c -20° ~ +50°C		

DIM6-IR/V



Dimmer LED con mando IR con salida de voltaje.
2 Canales.
Pueden añadirse amplifieds de CC y VC para aumentar la cantidad de leds controlables.
L87×An87×Al57(mm)

CE	IP20	Recycling	No Hazardous	Household	M M
12-24V CC	2 Canal	4A Máx	48/96W 12/24V	t_c -20° ~ +50°C	

Ejemplo de instalación pág: 72

LEDDIMMER



Dimmer Led de 1 canal.
L89×An60×Al51(mm)

CE	IP20	Recycling	No Hazardous	Household	M M
12-24V CC	1 Canal	8A Máx	96/192W 12/24V	t_c -20° ~ +50°C	

Ejemplo de instalación pág: 72

AVC-TRIACDIM360



Control de entrada mediante 220Vca para la mayoría de dimmer triac del mercado.
L167×An52×Al24(mm)

CE	IP20	Recycling	No Hazardous	Household	M M
12-24V CC	1 Canal	15A Máx	180/360W 12/24V	t_c -20° ~ +50°C	

Ejemplo de instalación pág: 105

AMPLILED2

Amplificador de potencia en voltaje.
3 canales de 4A por canal.
L110×An64×Al24(mm)

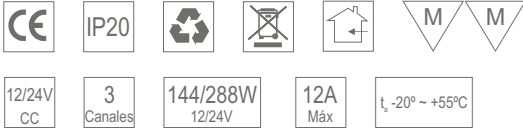

Ejemplo de instalación pág: 100



AMPLILED3

Amplificador de potencia en voltaje.
3 canales de 8A por canal.
L145×An76.8×Al20.5(mm)

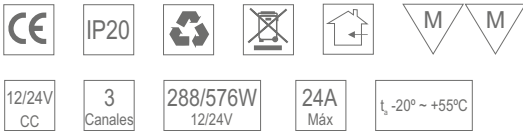

Ejemplo de instalación pág: 100



AMPLILED4

Amplificadores de potencia con corriente constante para LEDs de 1W (versión 300mA) o 3W (versión 700mA)
L125 ×An45 ×Al36 (mm)



Ejemplo de instalación pág: 100



REGULADORES



LEDCOM

Alimentadores C.C.



Convertidor diseñado para ubicar junto al LED de potencia.
Alimentación para diferentes tipos de LED 1W, 2W y 3W.
Dos versiones: 350 para leds de 1W y 700 para leds de 2 y 3W.
L15×An13×Al6(mm)



Ejemplo de instalación pág: 101

LEDCOM-RGB



Convertidor diseñado para ubicar junto al LED de potencia.
3 canales con hasta 3 LED por canal.
L25×An24×Al17(mm)

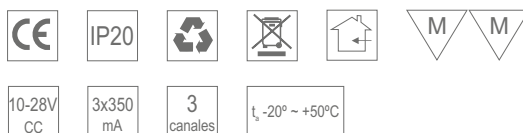

Ejemplo de instalación pág: 101

BULL



Alimentador diseñado para ubicar junto al LED de potencia.
Versión de 350mA para LEDs de 1W (hasta 4LED).
Versión de 500mA para LEDs de 2W (hasta 3LED).
L77,7×An34,5×Al21,5(mm)



Ejemplo de instalación pág: 102

SMART26



Alimentador diseñado para ubicar junto al LED de potencia.
Configurable para 350mA, 500mA, 550mA y 700mA.
L130×An41,8×Al30,5(mm)

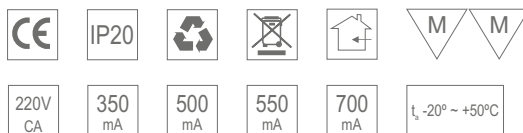

Ejemplo de instalación pág: 102

ALIMENTADORES

Alimentadores V.C.

LRS35

Alimentador conmutado para LEDs.
Disponible en 12V o 24V.
L91×An51×Al28(mm)

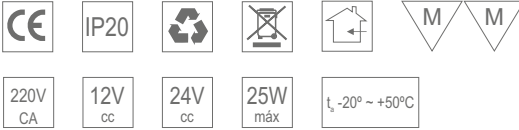
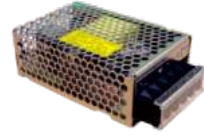

LRS50 / LRS75

Alimentador conmutado para LEDs.
Disponible en 12V o 24V.
L128×An98×Al38(mm)



ALIMENTADORES

LRS100

Alimentador conmutado para LEDs.
Disponible en 12V o 24V.
L159×An98×Al38(mm)



LRS150

Alimentador conmutado para LEDs.
Disponible en 12V o 24V.
L199×An98×Al38(mm)



GKF200

Alimentadores V.C.



Alimentador conmutado para LEDs.
Disponible en 12V o 24V.
L199×An99×Al49(mm)

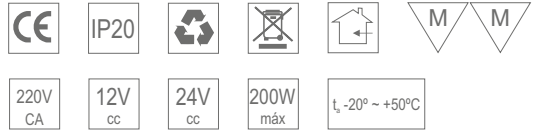

RSP320

ALIMENTADORES



Alimentador conmutado para LEDs.
Disponible en 12V o 24V.
L215×An115×Al30(mm)

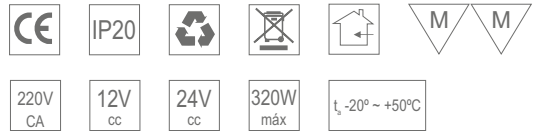

PDF500



Alimentador conmutado para LEDs.
Disponible en 12V o 24V.
L185×An120×Al93(mm)



LPH18



Alimentador para exterior conmutado para LEDs.
Disponible en 12V o 24V.
L139×An30×Al42(mm)

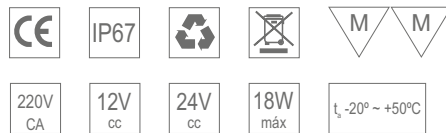

Alimentadores V.C.

LPV35

Alimentador para exterior conmutado para LEDs.
Disponible en 12V o 24V.
L139×An82×Al42(mm)

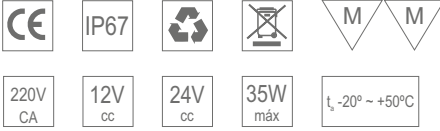

LPV60

Alimentador para exterior conmutado para LEDs.
Disponible en 12V, 24V o 48V.
L139×An82×Al42(mm)

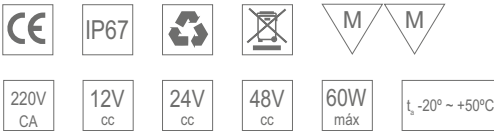

ALIMENTADORES

LPV100

Alimentador para exterior conmutado para LEDs.
Disponible en 12V o 24V.
L190×An52×Al37(mm)

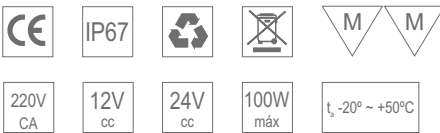

LPV150

Alimentador para exterior conmutado para LEDs.
Disponible en 12V o 24V.
L191×An63×Al37.5(mm)

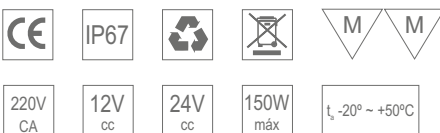

C-25CC

Alimentadores V.C. SAI
Sistemas de alimentación ininterrumpida para situaciones que se requiera una iluminación en todo momento.



Alimentador de corriente continua a 12V con baterías. (SAI)
Opcional 24V.
1 hora de potencia nominal.
L200×An240×Al90(mm)

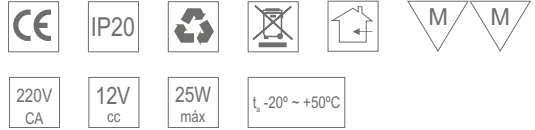

C-50CC



Alimentador de corriente continua a 12V con baterías. (SAI)
Opcional 24V.
1 hora de potencia nominal.
L200×An240×Al90(mm)



C-150CC



Alimentador de corriente continua a 12V con baterías. (SAI)
Opcional 24V.
1 hora de potencia nominal.
L240×An310×Al130(mm)



ALIMENTADORES





TIRAS LED

ELF/IP20

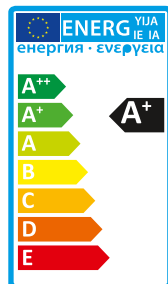

Bobinas de 5m de tiras flexibles de 60, 120 y 180 leds.

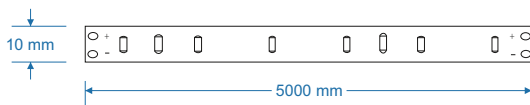

TIRAS LED



*Avance Luz recomienda un máximo de 8 metros para tiras inferiores a 10W/m y un máximo de 5m para tiras de mas de 10W/m.

REF.	V	IP	W	#leds	Beam	Lumen/m	K
ELF60/BF	12Vcc	20	4,8W/m	60/m (3528)	120°	390lm/m	6000°K
ELF60/BC	12Vcc	20	4,8W/m	60/m (3528)	120°	360lm/m	3000°K
ELF60/AM	12Vcc	20	4,8W/m	60/m (3528)	120°	120lm/m	/
ELF60/R	12Vcc	20	4,8W/m	60/m (3528)	120°	120lm/m	/
ELF60/V	12Vcc	20	4,8W/m	60/m (3528)	120°	240lm/m	/
ELF60/AZ	12Vcc	20	4,8W/m	60/m (3528)	120°	150lm/m	/
ELF120/BL	12Vcc	20	9,6W/m	120/m (2835)	120°	1250lm/m	6000°K
ELF120/BC	12Vcc	20	9,6W/m	120/m (2835)	120°	1175lm/m	3000°K
ELF180/BL	24Vcc	20	14,4W/m	60/m (5050)	120°	1150lm/m	6000°K
ELF180/BN	24Vcc	20	14,4W/m	60/m (5050)	120°	1127lm/m	4000°K
ELF180/BC	24Vcc	20	14,4W/m	60/m (5050)	120°	1104lm/m	3000°K

ELF/IP20/RGB



TIRAS LED

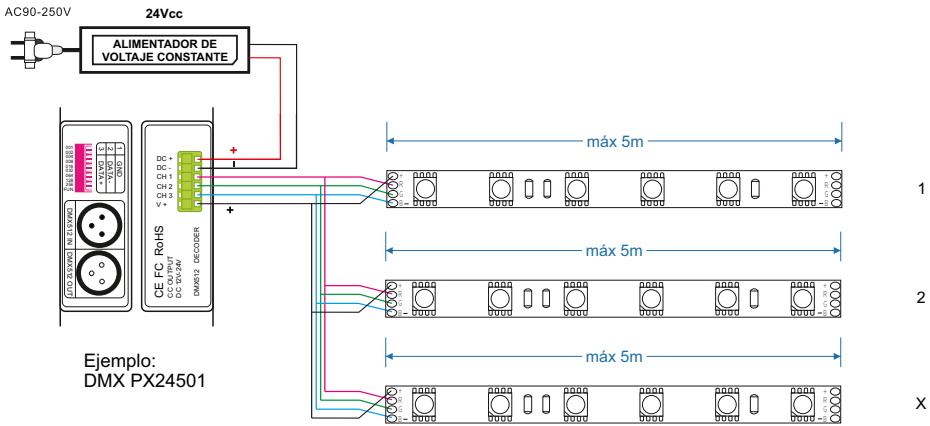

REF.	V	IP	W	#leds	Beam	Lumen	K
ELF30/RGB	24Vcc	20	7W/m	30/m (5050)	120°	~402Lm/m	/
ELF60/RGB	24Vcc	20	14,5W/m	60/m (5050)	120°	~804Lm/m	/

ELF/IP44

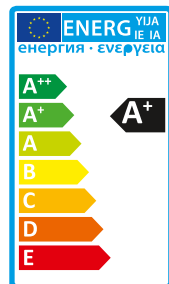

Bobinas de 5m de tiras flexibles de 60, 120 y 180 leds con protección IP44.

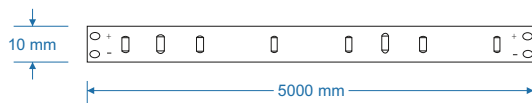

TIRAS LED



*Avance Luz recomienda un máximo de 8 metros para tiras inferiores a 10W/m y un máximo de 5m para tiras de mas de 10W/m.

REF.	V	IP	W	#leds	Beam	Lumen	K
ELF60/BF/W	12Vcc	44	4,8W/m	60/m (3528)	120°	390lm/m	6000°K
ELF60/BC/W	12Vcc	44	4,8W/m	60/m (3528)	120°	360lm/m	3000°K
ELF60/AM/W	12Vcc	44	4,8W/m	60/m (3528)	120°	120lm/m	/
ELF60/R/W	12Vcc	44	4,8W/m	60/m (3528)	120°	120lm/m	/
ELF60/V/W	12Vcc	44	4,8W/m	60/m (3528)	120°	240lm/m	/
ELF60/AZ/W	12Vcc	44	4,8W/m	60/m(3528)	120°	150lm/m	/
ELF120/BL/W	12Vcc	44	9,6W/m	120/m (2835)	120°	1250lm/m	6000°K
ELF120/BC/W	12Vcc	44	9,6W/m	120/m (2835)	120°	1175lm/m	3000°K
ELF180/BL/W	24Vcc	44	14,4W/m	60/m (5050)	120°	1150lm/m	6000°K
ELF180/BN/W	24Vcc	44	14,4W/m	60/m (5050)	120°	1127lm/m	4000°K
ELF180/BC/W	24Vcc	44	14,4W/m	60/m (5050)	120°	1104lm/m	3000°K

ELF/RGB/IP44



TIRAS LED

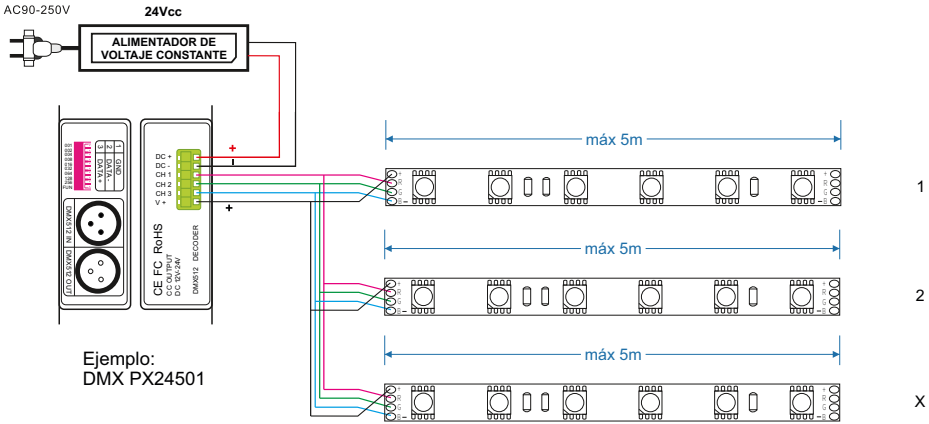

REF.	V	IP	W	#leds	Beam	Lumen	K
ELF30/RGB/W	24Vcc	44	7W/m	30/m (5050)	120°	~402lm/m	/
ELF60/RGB/W	24Vcc	44	14,5W/m	60/m (5050)	120°	~804lm/m	/

PLF/IP20

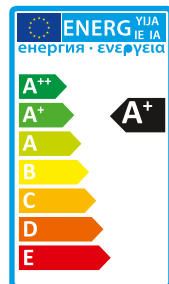

Tiras profesionales PROLEDFLEX de alto CRI y durabilidad.
Suministradas en bobinas de 5m.

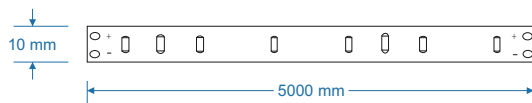

TIRAS LED



*Avance Luz recomienda un máximo de 8 metros para tiras inferiores a 10W/m y un máximo de 5m para tiras de mas de 10W/m.

REF.	V	IP	W	#leds	Beam	Lumen	K
PLF5630/6K	24Vcc	20	19W/m	60/m (5630)	120°	1520lm/m	6000°K
PLF5630/4K	24Vcc	20	19W/m	60/m (5630)	120°	1489lm/m	4000°K
PLF5630/3K	24Vcc	20	19W/m	60/m (5630)	120°	1459lm/m	3000°K
PLF5630/2.8	24Vcc	20	19W/m	60/m (5630)	120°	1455lm/m	2800°K
PLF120/BF	24Vcc	20	13W/m	120/m (2835)	120°	1250lm/m	6000°K
PLF120/BN	24Vcc	20	13W/m	120/m (2835)	120°	1150lm/m	4000°K
PLF120/BC	24Vcc	20	13W/m	120/m (2835)	120°	1050lm/m	3000°K
PLF180/BF	24Vcc	20	15W/m	60/m (5050)	120°	1305lm/m	6000°K
PLF180/BN	24Vcc	20	15W/m	60/m (5050)	120°	1278lm/m	4000°K
PLF180/BC	24Vcc	20	15W/m	60/m (5050)	120°	1253lm/m	3000°K
PLF240/CTA	24Vcc	20	22W/m	240/m (2216)	120°	1510lm/m	2300-6000°K

PLF/IP20/RGB



TIRAS LED

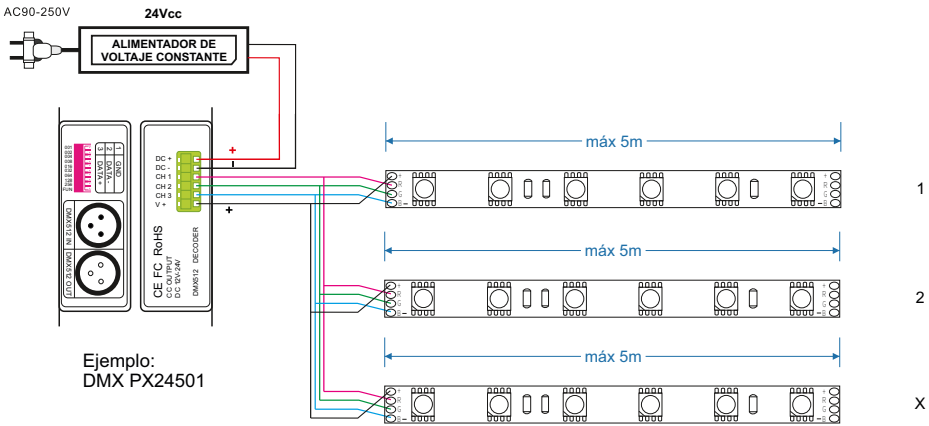

REF.	V	IP	W	#leds	Beam	Lumen	K
PLF30/RGB	24Vcc	20	7W/m	30/m (5050)	120°	~402Lm/m	/
PLF60/RGB	24Vcc	20	15W/m	60/m (5050)	120°	~804Lm/m	/
PLF60/RGBW	24Vcc	20	18W/m	60/m (5050)	120°	~1020Lm/m	/

PLF/IP44

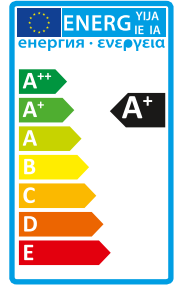

Tiras profesionales PROLEDFLEX de alto CRI y durabilidad.
Suministradas en bobinas de 2,5m.

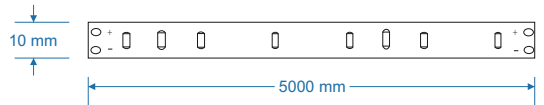

TIRAS LED



*Avance Luz recomienda un máximo de 8 metros para tiras inferiores a 10W/m y un máximo de 5m para tiras de mas de 10W/m.

REF.	V	IP	W	#leds	Beam	Lumen	K
PLF5630/6K/W	24Vcc	44	19W/m	60/m (5630)	120°	1520lm/m	6000°K
PLF5630/4K/W	24Vcc	44	19W/m	60/m (5630)	120°	1489lm/m	4000°K
PLF5630/3K/W	24Vcc	44	19W/m	60/m (5630)	120°	1459lm/m	3000°K
PLF5630/2.8/W	24Vcc	44	19W/m	60/m (5630)	120°	1455lm/m	2800°K
PLF120/BF/W	24Vcc	44	13W/m	120/m (2835)	120°	1250lm/m	6000°K
PLF120/BN/W	24Vcc	44	13W/m	120/m (2835)	120°	1150lm/m	4000°K
PLF120/BC/W	24Vcc	44	13W/m	120/m (2835)	120°	1050lm/m	3000°K
PLF180/BF/W	24Vcc	44	15W/m	60/m (5050)	120°	1305lm/m	6000°K
PLF180/BN/W	24Vcc	44	15W/m	60/m (5050)	120°	1278lm/m	4000°K
PLF180/BC/W	24Vcc	44	15W/m	60/m (5050)	120°	1253lm/m	3000°K
PLF240/CTA/W	24Vcc	44	22W/m	240/m (2216)	120°	1510lm/m	2300-6000°K

PLF/RGB/IP44



TIRAS LED

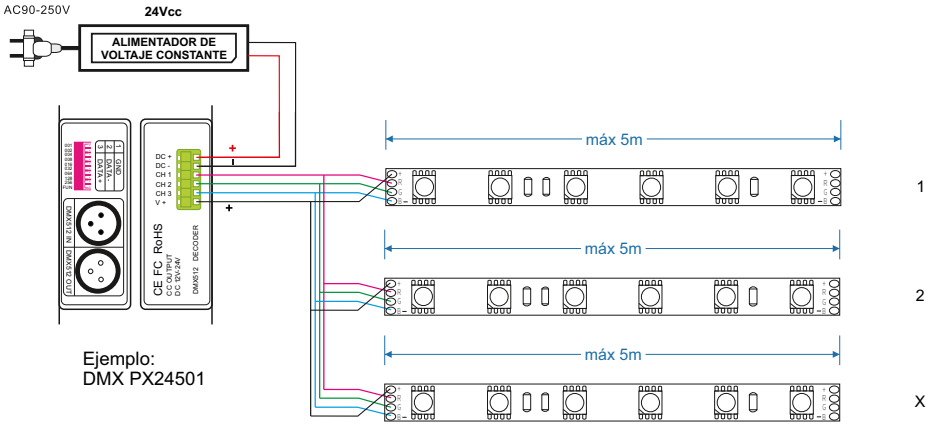

REF.	V	IP	W	#leds	Beam	Lumen	K
PLF30/RGB/W	24Vcc	44	7W/m	30/m (5050)	120°	~402Lm/m	/
PLF60/RGB/W	24Vcc	44	15W/m	60/m (5050)	120°	~804Lm/m	/
PLF60/RGBW/W	24Vcc	44	18W/m	60/m (5050)	120°	~1020Lm/m	/

ILUMINACIÓN EN YATES

Extremadamente durable para resistir el desafío del agua del mar, protección completa de las tiras LED manteniéndose igual mientras hacen frente al fuerte viento y las grandes olas.



GALERIAS COMERCIALES

Crear un aspecto elegante y moderno en el área comercial, y demostrar una elegante atmósfera de iluminación arquitectónica de diseño.





ILUMINACIÓN DE FACHADAS

Muestra un estilo futurista que no solo decora los edificios sino que además mantiene el mejor y estable efecto lumínico.

TIRAS LED



ILUMINACIÓN DE PISCINAS

Resistente al sol, no se decolora, no se cuartea.

LLF/MN



TIRAS LED



Para instalaciones en exterior o subacuáticas.
Suministrado en bobinas de 5m.
Encapsulado PU para la máxima protección.

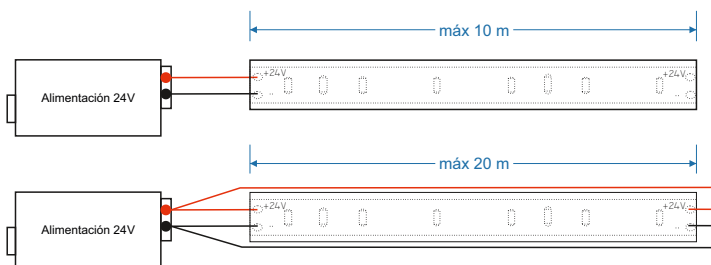
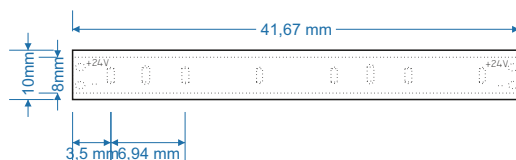

REF.	V	IP	W	#leds	Beam	Lumen	K
LLF/MN/BF	24Vcc	67	10W/m	144/m (3014)	150°	800Lm/m	6500°K
LLF/MN/BC	24Vcc	67	10W/m	144/m (3014)	150°	630Lm/m	2700°K
LLF/MN/BN	24Vcc	67	10W/m	144/m (3014)	150°	800Lm/m	4000°K
LLFMN/R	24Vcc	67	10W/m	144/m (3014)	150°	210Lm/m	/
LLF/MN/Az	24Vcc	67	10W/m	144/m (3014)	150°	150Lm/m	/
LLF/MN/V	24Vcc	67	10W/m	144/m (3014)	150°	230Lm/m	/
LLF/MN/Am	24Vcc	67	10W/m	144/m (3014)	150°	450Lm/m	/

LLF/MN/RGB



IP67



CRI>80

t_a -20° ~ +40°C



TIRAS LED

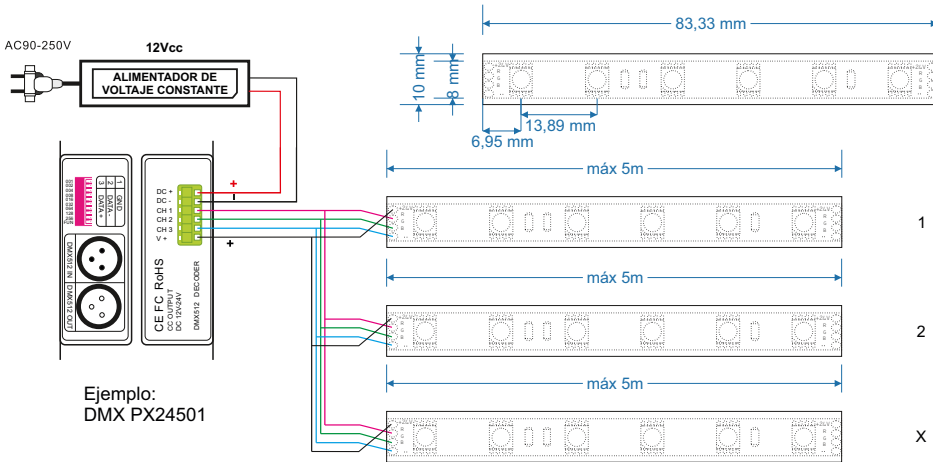

REF.	V	IP	W	#leds	Beam	Lumen	K
LLF/MN/RGB	24Vcc	67	10W/m	72/m (5050)	150°	450Lm/m	/

LLF/TOP



TIRAS LED

Para instalaciones en exterior o subacuáticas.
Suministrado en bobinas de 5m.
Encapsulado PU para la máxima protección.

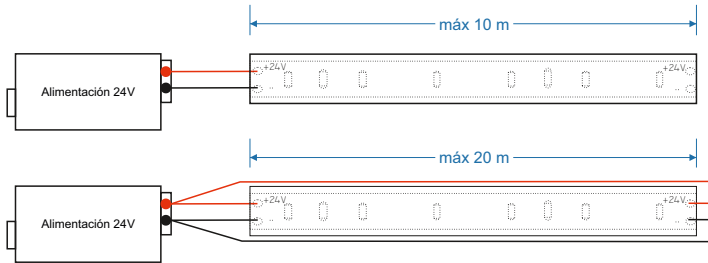
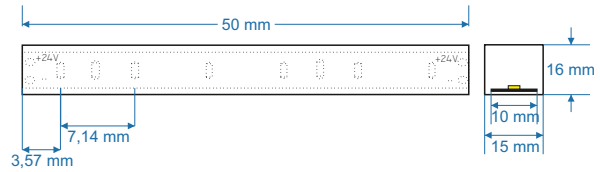

REF.	V	IP	W	#leds	Beam	Lumen	K
LLF/TOP/BF	24Vcc	68	10W/m	144/m (3014)	150°	800Lm/m	6500°K
LLF/TOP/BC	24Vcc	68	10W/m	144/m (3014)	150°	630Lm/m	2700°K
LLF/TOP/BN	24Vcc	68	10W/m	144/m (3014)	150°	800Lm/m	4000°K
LLF/TOP/R	24Vcc	68	10W/m	144/m (3014)	150°	210Lm/m	/
LLF/TOP/Az	24Vcc	68	10W/m	144/m (3014)	150°	150Lm/m	/
LLF/TOP/V	24Vcc	68	10W/m	144/m (3014)	150°	230Lm/m	/
LLF/TOP/Am	24Vcc	68	10W/m	144/m (3014)	150°	450Lm/m	/

LLF/TOP/RGB



IP68



CRI>80

t_a -20° ~ +40°C



TIRAS LED

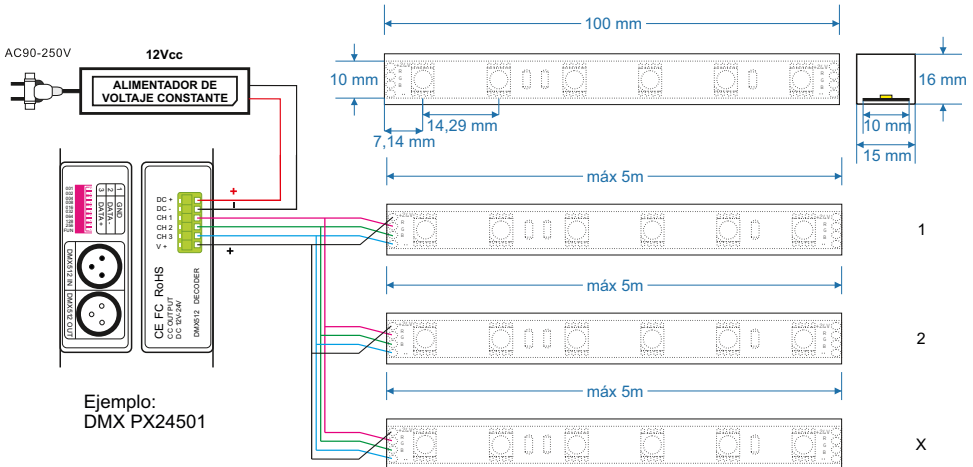

REF.	V	IP	W	#leds	Beam	Lumen	K
LLF/TOP/RGB	24Vcc	68	10W/m	72/m (5050)	150°	450Lm/m	/

LT POWER

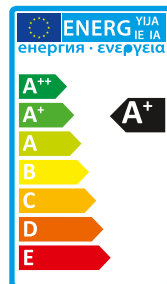

Suministradas en tiras de 390mm.

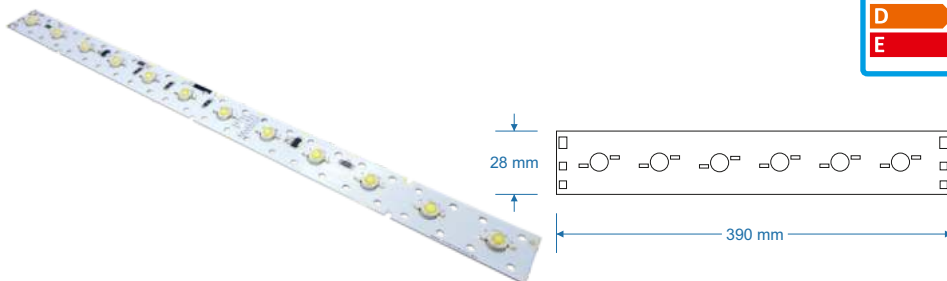

TIRAS LED

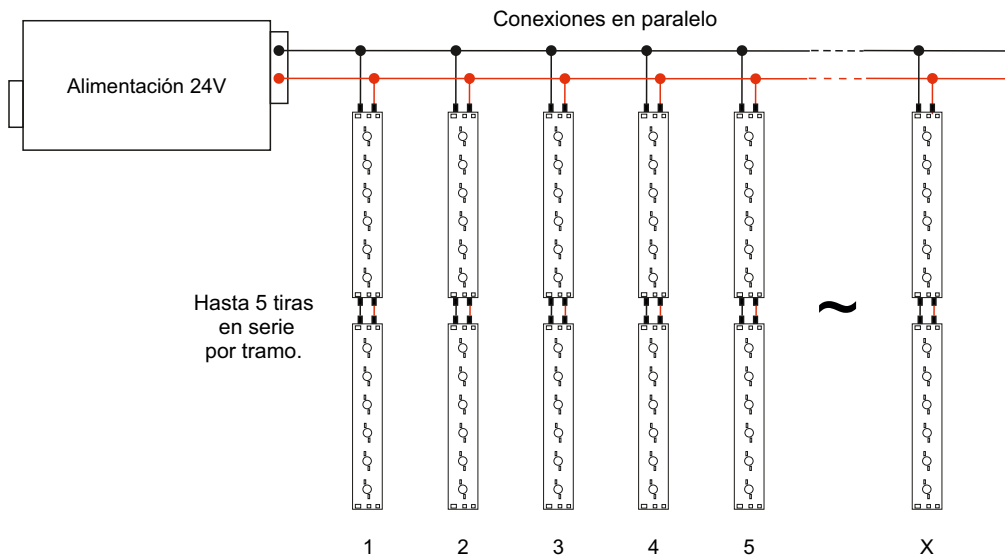

REF.	V	I	W	#leds	Beam	Lumen	K
LEDTIRA6x1W/BF	24Vcc	350mA	6W	6	120°	900Lm	6000°K
LEDTIRA6x1W/BC	24Vcc	350mA	6W	6	120°	740Lm	3000°K
LEDTIRA12x1W/BF	24Vcc	350mA	12W	12	120°	1800Lm	6000°K
LEDTIRA12x1W/BC	24Vcc	350mA	12W	12	120°	1480Lm	3000°K
LEDTIRA12x1W/CTA	24Vcc	2x350mA	12W	6WW+6CW	120°	1640Lm	2900-5900°K
LEDTIRA6x3W/BF	24Vcc	700mA	18W	6	120°	1500Lm	6000°K
LEDTIRA6x3W/BC	24Vcc	700mA	18W	6	120°	1200Lm	3000°K

LT POWER RGB

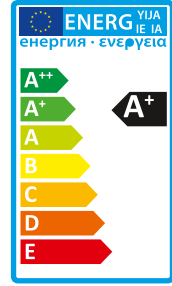

Suministradas en tiras de 390mm.

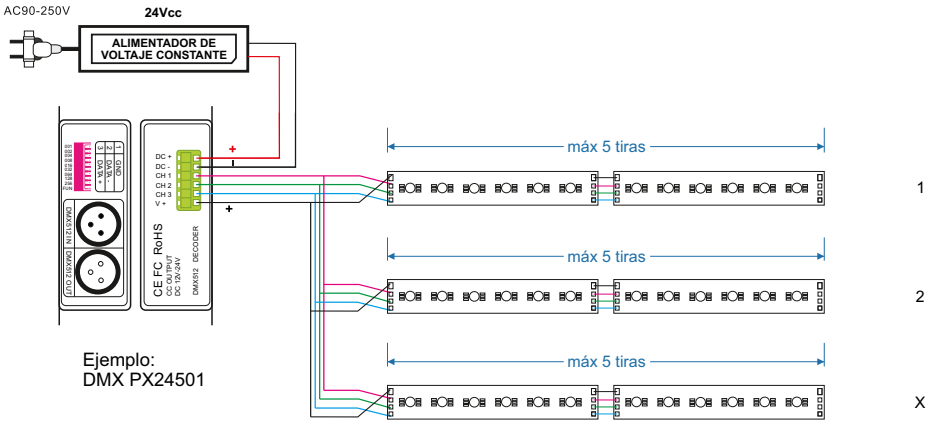
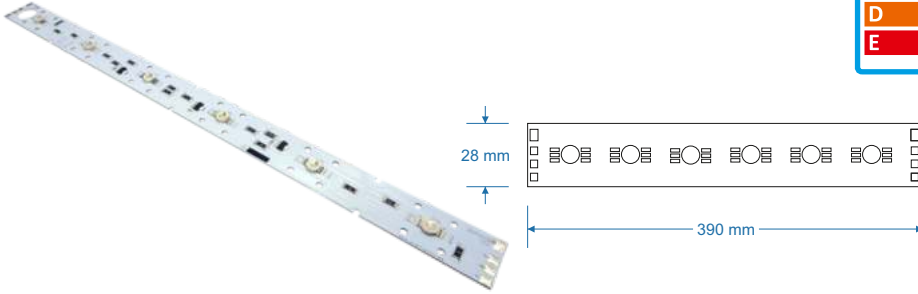

TIRAS LED

REF.	V	I	W	#leds	Beam	Lumen	K
LEDTIRARGB3x3W	24Vcc	350mA	9W	3	120°	~585Lm	/
LEDTIRARGB5x3W	24Vcc	350mA	15W	5	120°	~975Lm	/
LEDTIRARGB6x3W	24Vcc	350mA	18W	6	120°	~1170Lm	/

PERFILES



Disponibles de manera entandar en 2 y 3 metros y a medida hasta 6 metros en todos los modelos.

Le ofrecemos la fabricación según sus requerimientos de la luminaria acabada.

P100

Perfil de montaje de aluminio para cadenas modulares y cintas de hasta un ancho de 10mm.
Aluminio anodizado natural.
Sección compacta (5,99 x 15,9 mm).

Compatible con:

Clip-201

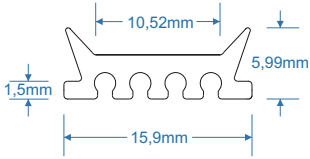

P101

Perfil de montaje de aluminio para cadenas modulares y cintas de hasta un ancho de 11mm.
Aluminio anodizado natural.
Sección compacta (9 x 17 mm).

Compatible con:

LenLine-P-Opal
LenLine-P-Frost
LenLine-P-120

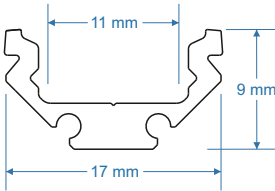

P102

Perfil de montaje de aluminio para cadenas modulares y cintas de hasta un ancho de 12mm.
Aluminio anodizado natural.
Sección compacta (7 x 25 mm).

Compatible con:

Clip102
Tapa102
LenLine-P-Opal
LenLine-P-Frost
LenLine-P-120

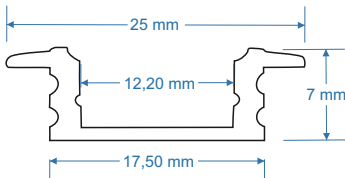

P103

Perfil de montaje de aluminio para cadenas modulares y cintas de hasta un ancho de 12mm.
Aluminio anodizado natural.
Sección compacta (15 x 25 mm).

Compatible con:

Clip103
Tapa103
LenLine-P-Opal
LenLine-P-Frost
LenLine-P-120

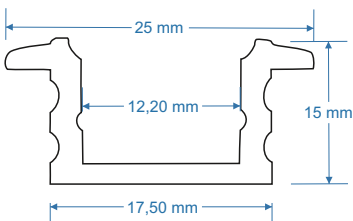

PERFILES

Disponibles de manera estandar en 2 y 3 metros y a medida hasta 6 metros en todos los modelos.

P104

Le ofrecemos la fabricación según sus requerimientos de la luminaria acabada.

Perfil de montaje de aluminio para cadenas modulares y cintas de hasta un ancho de 12mm.
Aluminio anodizado natural.
Sección compacta (7 x 17,5 mm).



Compatible con:

Clip102
Tapa104
LenLine-P-Opal
LenLine-P-Frost
LenLine-P-120

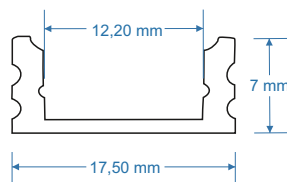

P105

Perfil de montaje de aluminio para cadenas modulares y cintas de hasta un ancho de 12mm.
Aluminio anodizado natural.
Sección compacta (15 x 17,5 mm).

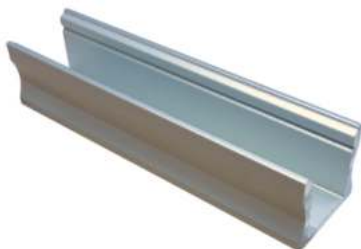

Compatible con:

Clip103
Tapa105
LenLine-P-Opal
LenLine-P-Frost
LenLine-P-120

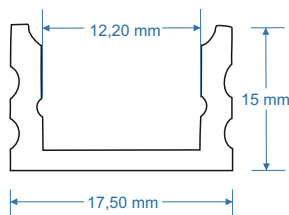

P201

Perfil de montaje de aluminio para cadenas modulares y cintas de hasta un ancho de 12mm.
Aluminio anodizado natural.
Sección compacta (10 x 17,65 mm).

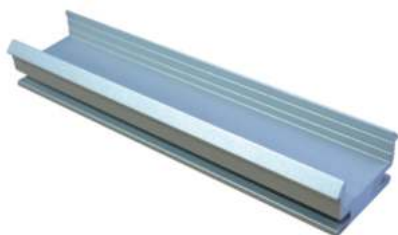

Compatible con:

Clip201
Tapa201
LenLine-30°
LenLine-90°
LenLine-120°
LenLine-Opal
LenLine-Frost

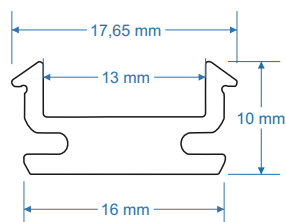

P202

Perfil de montaje de aluminio para cadenas modulares y cintas de hasta un ancho de 12mm.
Aluminio anodizado natural.
Sección compacta (16,50 x 17,65 mm).



Compatible con:

Clip201
Tapa202
LenLine-30°
LenLine-90°
LenLine-120°
LenLine-Opal
LenLine-Frost

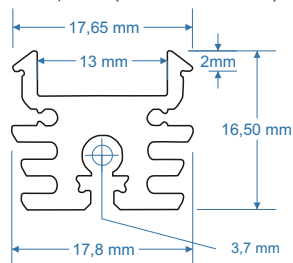

Disponibles de manera entandar en 2 y 3 metros y a medida hasta 6 metros en todos los modelos.

Le ofrecemos la fabricación según sus requerimientos de la luminaria acabada.

P203

Perfil de montaje de aluminio para cadenas modulares y cintas de hasta un ancho de 10mm.
Aluminio anodizado natural.
Sección compacta (5,99 x 15,9 mm).

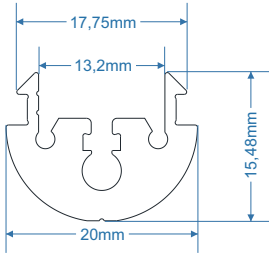

Compatible con:

SLP203
SL202
P23/SU
Tapa203
LenLine-30°
LenLine-90°
LenLine-120°
LenLine-Opal
LenLine-Frost



PERFIL-P-1M

Perfil de montaje de aluminio para cadenas modulares y cintas de hasta un ancho de 10mm.
Aluminio anodizado natural.
Sección (11 x 70 mm).

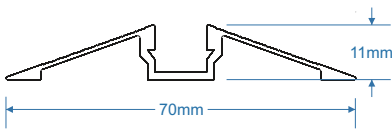

Compatible con:

PVC/P

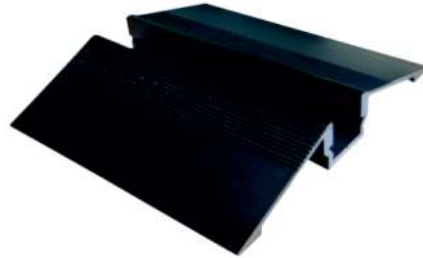

PEL-SOL

Perfil de montaje de aluminio para cadenas modulares y cintas de hasta un ancho de 10mm.
Aluminio anodizado natural.
Sección (29,6 x 70,8 mm).

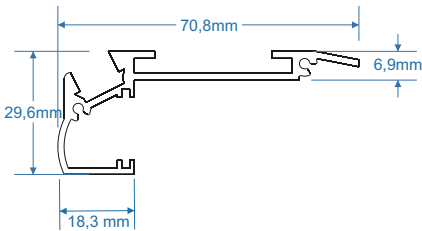

Compatible con:

Tapa/Perfil/pel
Gomapel
Gomapel/S
PVC/P

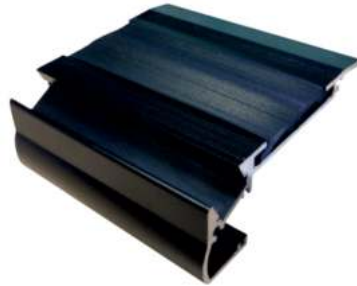

PERFIL-P-E-1M

Perfil de montaje de aluminio para cadenas modulares y cintas de hasta un ancho de 10mm.
Aluminio anodizado natural.
Sección compacta (16 x 28 mm).

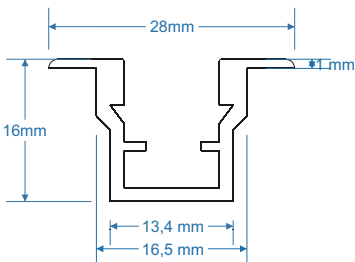

Compatible con:

PVC/P



PERFILES

P204



PERFILES

El perfil P204 está especialmente diseñado para empotrar en suelos con una estructura mas robusta y la cubierta mucho mas gruesa, hace posible que sea pisable dando nuevas posibilidades a la iluminación de suelos pudiendo crear efectos que no dejaran desapercibido a nadie.

Perfil de montaje de aluminio para cadenas modulares y cintas de hasta un ancho de 10mm. Especialmente diseñado para empotrar en suelos. Aluminio anodizado natural. Sección compacta (9 x 20 mm).

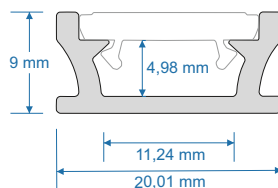

ACCESORIOS

P2040PAL

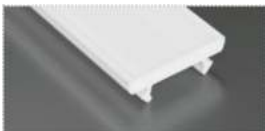

P204FROST

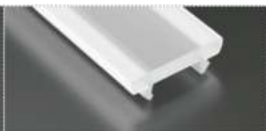

P204TAPA





El perfil P205 está especialmente diseñado para proporcionar una alta luminosidad al poder contar con hasta triple tira de leds. Se puede empotrar, montar en superficie, o mediante el elemento suspensor colocarlo de manera flotante. El alimentador de las tiras flexibles se puede instalar dentro del propio perfil, y este cuenta con una tapa de aluminio que permite ocultarlo. Dada su profundidad, mediante la lente P205OPAL los puntos de luz se difuminan y la luz se muestra de forma homogénea.

Perfil de montaje de aluminio para cadenas modulares y cintas de hasta un ancho de 30 mm. Aluminio anodizado natural. Sección para triple tira (30 x 43 mm).

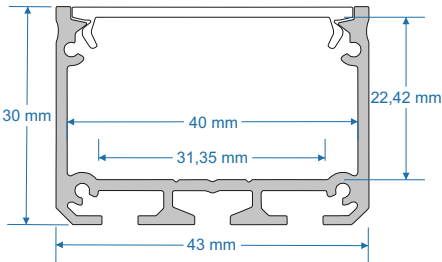

PERFILES

ACCESORIOS

P205TRANSP

P205FROST

P205OPAL

P205TAPA

P205ALU

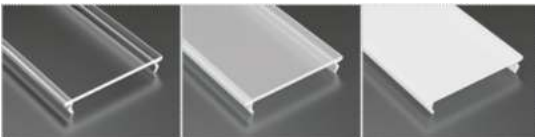

LNL/30°

Lente en PMMA con apertura de 30° y acabado **transparente** para perfiles extrusionados.

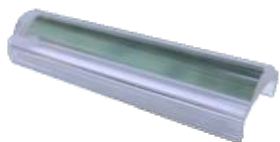

Compatible con:

P201
P202
P203

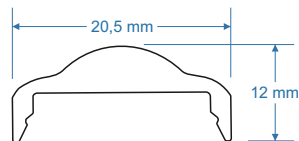

LNL/90°

Lente en PMMA con apertura de 90° y acabado **transparente** para perfiles extrusionados.



Compatible con:

P201
P202
P203

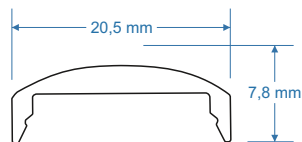

LNL/120°

Lente en PMMA con apertura de 120° y acabado **transparente** para perfiles extrusionados.



Compatible con:

P201
P202
P203

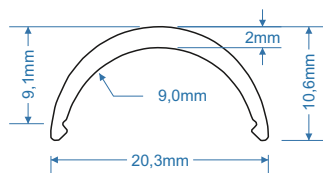

LNL/Frost

Lente en PMMA con apertura de 120° y acabado **frost** para perfiles extrusionados.



Compatible con:

P201
P202
P203

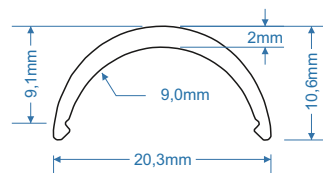

LNL/Opal

Lente en PMMA con apertura de 120° y acabado **opal** para perfiles extrusionados.

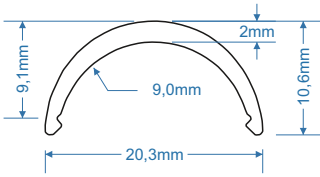

Compatible con:

P201
P202
P203



LNL/P/Frost

Lente plana en PMMA con apertura de 120° y acabado **frost** para perfiles extrusionados.

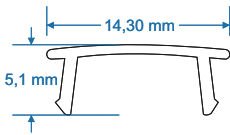

Compatible con:

P101
P102
P103
P104
P105



LNL/P/Opal

Lente plana en PMMA con apertura de 120° y acabado **Opal** para perfiles extrusionados.

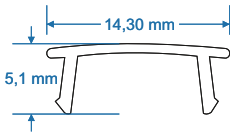

Compatible con:

P101
P102
P103
P104
P105



LNL/P/120

Lente plana en PMMA con apertura de 120° y acabado **transparente** para perfiles extrusionados.

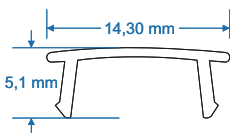

Compatible con:

P101
P102
P103
P104
P105



ACCESORIOS PERFILES

	REF:	DESCRIPCIÓN:
	PVC/P	Cubierta PVC para perfiles peldaño / pasillo / empotrar.
	CLIP102	Clip de fijación metálico para perfiles P102 y P104.
	CLIP103	Clip de fijación metálico para perfiles P103, P105, P201 y P202.
	CLIP201	Clip de fijación plástico para perfiles P100, P201 y P202.
	TAPA102	Tapa lateral en PVC para el perfil P102.
	TAPA103	Tapa lateral en PVC para el perfil P103.
	TAPA104	Tapa lateral en PVC para el perfil P104.
	TAPA105	Tapa lateral en PVC para el perfil P105.
	TAPA201	Tapa lateral metálica para el perfil P201.
	TAPA202	Tapa lateral metálica para el perfil P202.
	TAPA203	Tapa lateral metálica para el perfil P203.
	TAPAPERFILPEL	Tapa lateral metálica para el perfil PEL-SOL.
	SLP203	Accesorio para la instalación lateral del perfil P203.
	SL202	Accesorio para la instalación lateral del perfil P202 y P203.
	P23/SU	Accesorio suspensor para el perfil P203.
	P/SU	Accesorio suspensor para el perfiles.
	GOMAPEL	Goma superior antideslizante para PEL-SOL.
	GOMAPEL/S	Goma inferior de fijación en cuña para PEL-SOL.



APLIQUES

APL01

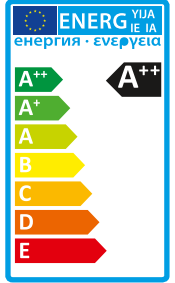

Montaje en orificio de Ø17mm con su rosca.
Suministrado con cable de 20cm.

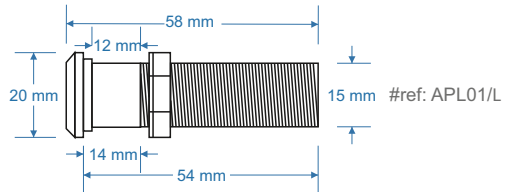
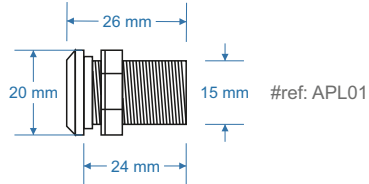
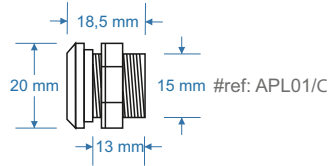

Conexiones en serie

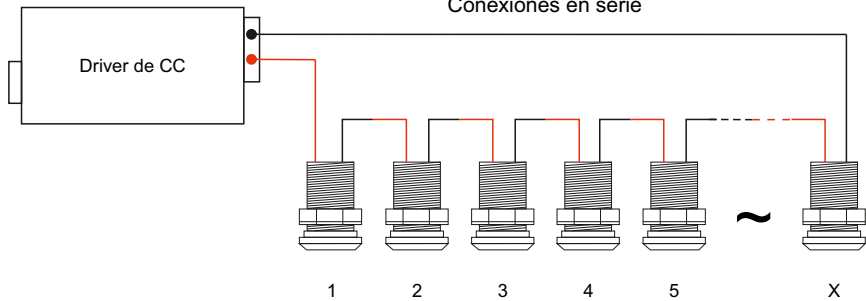

APLIQUES

REF.	V	I	W	#leds	Beam	Lumen (@350mA)	K
APL01/BF	3Vcc	350mA/500mA	1,25W/2W*	1	25°/45°/60°	150Lm	5000°K
APL01/BN	3Vcc	350mA/500mA	1,25W/2W*	1	25°/45°/60°	130Lm	4000°K
APL01/BC	3Vcc	350mA/500mA	1,25W/2W*	1	25°/45°/60°	123Lm	3000°K
APL01/2.7	3Vcc	350mA/500mA	1,25W/2W*	1	25°/45°/60°	119Lm	2700°K
APL01/AM	3Vcc	350mA/500mA	1,25W/2W*	1	25°/45°/60°	80.6Lm	/
APL01/AZ	3Vcc	350mA/500mA	1,25W/2W*	1	25°/45°/60°	39.8Lm	/
APL01/R	3Vcc	350mA/500mA	1,25W/2W*	1	25°/45°/60°	73.9Lm	/
APL01/V	3Vcc	350mA/500mA	1,25W/2W*	1	25°/45°/60°	93.9Lm	/

*Versión 500mA y 2W disponible solo en APL01/L

APL02



Montaje en orificio de Ø30mm con su rosca.
Disponibles en 6 colores diferentes.
Suministrado con cable de 20cm.

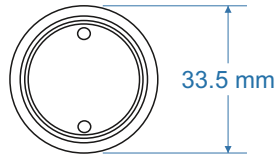
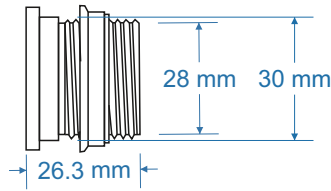
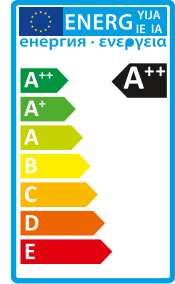

Conexiones en serie

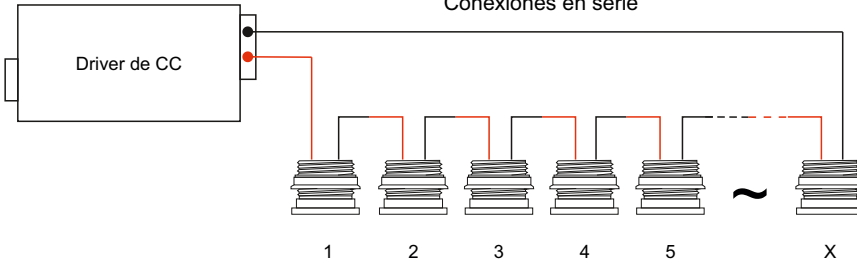

APLIQUES

REF.	V	I	W	#leds	Beam	Lumen (@350mA)	K
APL02/BF	3Vcc	350mA/500mA	1,25W/2W*	1	30°/45°	150Lm	5000°K
APL02/BN	3Vcc	350mA/500mA	1,25W/2W*	1	30°/45°	130Lm	4000°K
APL02/BC	3Vcc	350mA/500mA	1,25W/2W*	1	30°/45°	123Lm	3000°K
APL02/2.7	3Vcc	350mA/500mA	1,25W/2W*	1	30°/45°	119Lm	2700°K

*En caso de instalarse en una superficie metálica permite la alimentación a 500mA (2W).

APL03

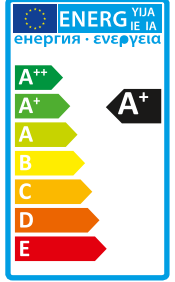

Montaje en orificio de Ø30mm con muelles.
Suministrado con cable de 1m.

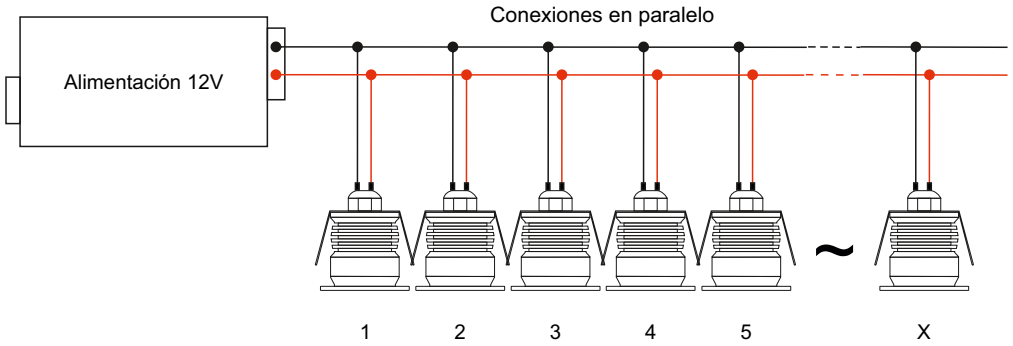
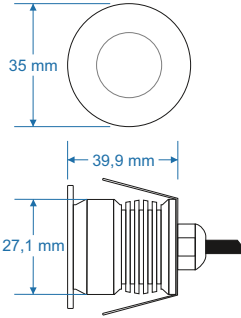

APLIQUES

REF.	V	IP	W	#leds	Beam	Lumen	K
APL03/BF	12/24Vcc	67	1W	1	15°/30°/60°	95Lm	5000°K
APL03/BC	12/24Vcc	67	1W	1	15°/30°/60°	87Lm	3000°K
APL03/BN	12/24Vcc	67	1W	1	15°/30°/60°	91Lm	4000°K

APL04



Montaje en orificio de Ø34mm con muelles.
Suministrado con cable de 20cm.

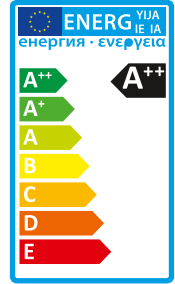
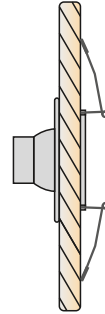
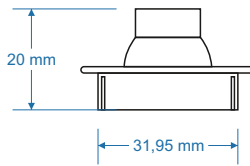
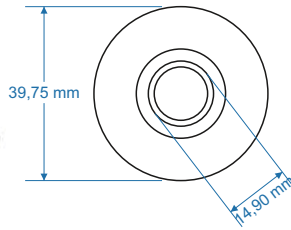

Conexiones en serie

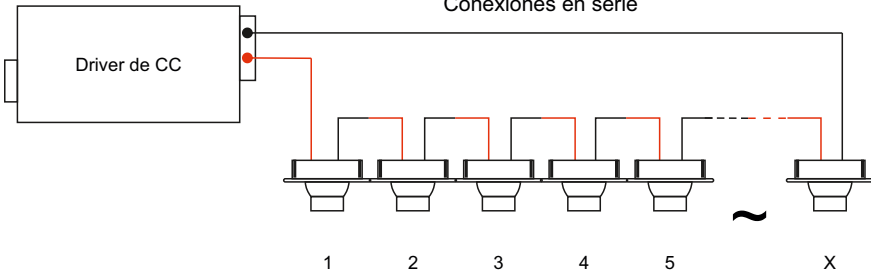

APLIQUES

REF.	V	I	W	#leds	Beam	Lumen (@350mA)	K
APL04/BF	3Vcc	350mA/500mA	1,25W/2W	1	25°/45°/60°	122Lm	5000°K
APL04/BC	3Vcc	350mA/500mA	1,25W/2W	1	25°/45°/60°	93.9Lm	3000°K
APL04/BN	3Vcc	350mA/500mA	1,25W/2W	1	25°/45°/60°	107Lm	4000°K

APL35/12

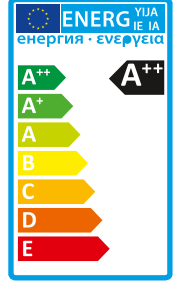

Montaje a presión en orificio de Ø26mm.
Suministrado con cable de 20cm.

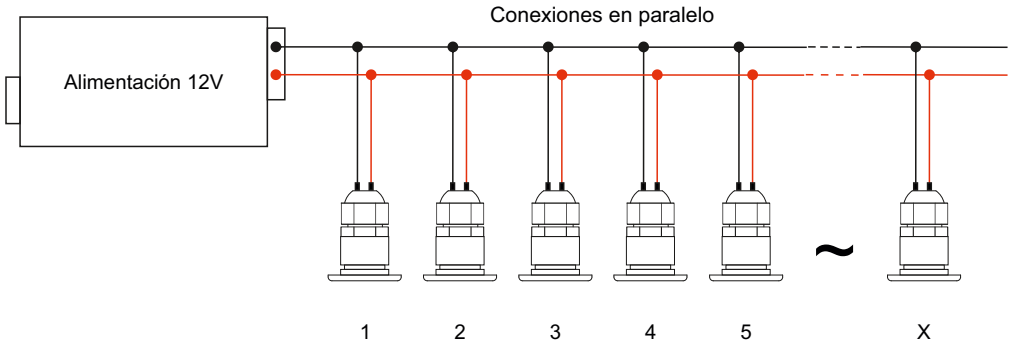
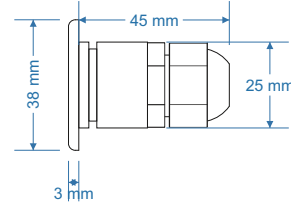
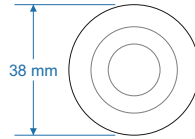

APLIQUES

REF.	V	I	W	#leds	Beam	Lumen	K
APL35/12/BF	12Vcc*	20mA	0,24W	1	20°	1,9Lm	6000°K
APL35/12/AM	12Vcc*	20mA	0,24W	1	20°	0,66Lm	/
APL35/12/AZ	12Vcc*	20mA	0,24W	1	20°	1,43Lm	/
APL35/12/R	12Vcc*	20mA	0,24W	1	20°	1Lm	/
APL35/12/V	12Vcc*	20mA	0,24W	1	20°	1,9Lm	/

*Versión 24V opcional.

APL35



Montaje a presión en orificio de Ø26mm.
Suministrado con cable de 20cm.

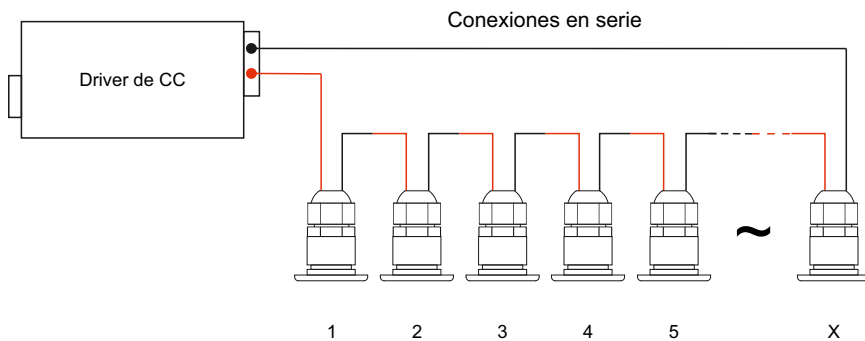
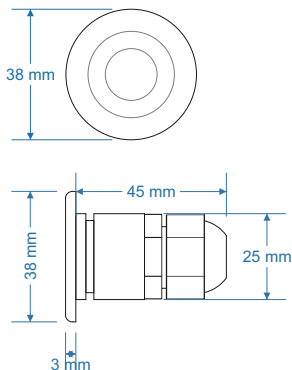
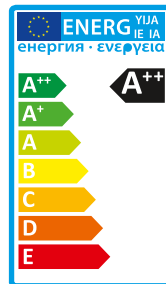

APLIQUES

REF.	V	I	W	#leds	Beam	Lumen (@350mA)	K
APL35/BF	3Vcc	350mA	1,25W	1	25°/45°/60°	122Lm	5000°K
APL35/BC	3Vcc	350mA	1,25W	1	25°/45°/60°	93.9Lm	3000°K
APL35/BN	3Vcc	350mA	1,25W	1	25°/45°/60°	107Lm	4000°K
APL35/AM	3Vcc	350mA	1,25W	1	25°/45°/60°	80.6Lm	/
APL35/AZ	3Vcc	350mA	1,25W	1	25°/45°/60°	39.8Lm	/
APL35/R	3Vcc	350mA	1,25W	1	25°/45°/60°	73.9Lm	/
APL35/V	3Vcc	350mA	1,25W	1	25°/45°/60°	93.9Lm	/

APL36

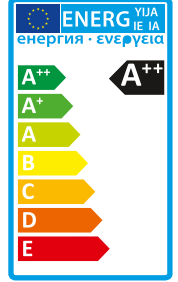

Montaje a presión en orificio de Ø12mm.
Suministrado con cable de 20cm.

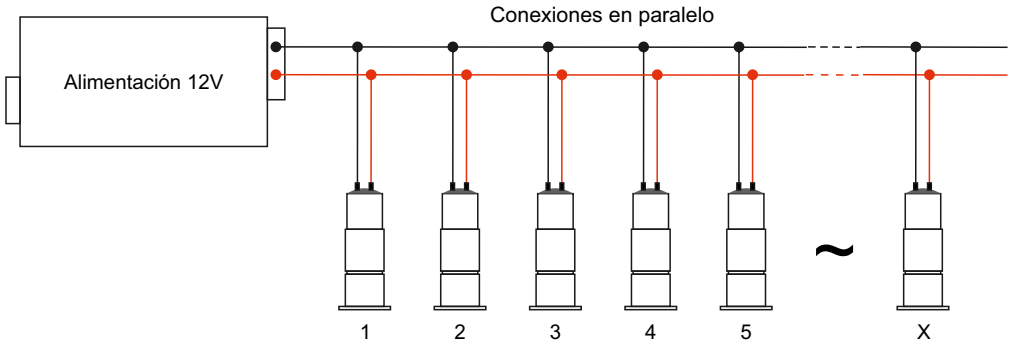
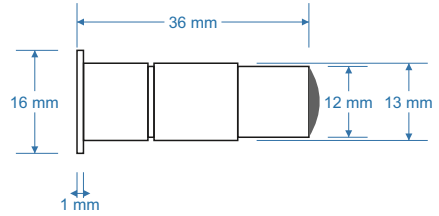
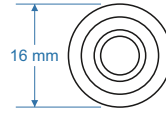

APLIQUES

REF.	V	I	W	#leds	Beam	Lumen	K
APL36/BF	12Vcc*	20mA	0,24W	1	20°	1,9Lm	5000°K
APL36/AM	12Vcc*	20mA	0,24W	1	20°	0,66Lm	/
APL36/AZ	12Vcc*	20mA	0,24W	1	20°	1,43Lm	/
APL36/R	12Vcc*	20mA	0,24W	1	20°	1Lm	/
APL36/V	12Vcc*	20mA	0,24W	1	20°	1,9Lm	/

*Versión 24V opcional.

APL36/1W

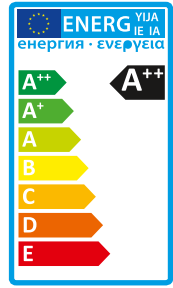

Montaje en orificio de Ø13mm con su rosca.
Suministrado con cable de 20cm.

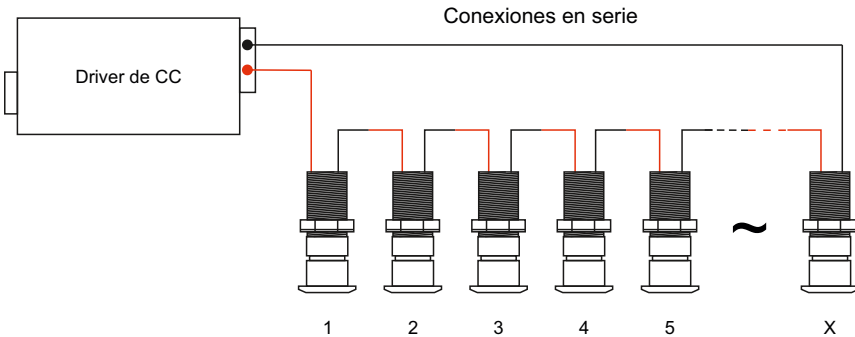
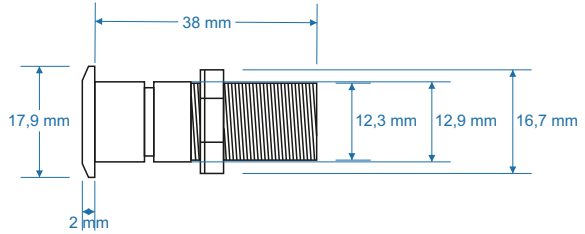
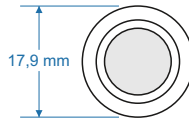

APLIQUES

REF.	V	I	W	#leds	Beam	Lumen (@350mA)	K
APL36/1W/BF	3Vcc	350mA	1,25W	1	25°/45°/60°	122Lm	5000°K
APL36/1W/BC	3Vcc	350mA	1,25W	1	25°/45°/60°	93.9Lm	3000°K
APL36/1W/BN	3Vcc	350mA	1,25W	1	25°/45°/60°	107Lm	4000°K
APL36/1W/AM	3Vcc	350mA	1,25W	1	25°/45°/60°	80.6Lm	/
APL36/1W/AZ	3Vcc	350mA	1,25W	1	25°/45°/60°	39.8Lm	/
APL36/1W/R	3Vcc	350mA	1,25W	1	25°/45°/60°	73.9Lm	/
APL36/1W/V	3Vcc	350mA	1,25W	1	25°/45°/60°	93.9Lm	/

LEDTRIOTC

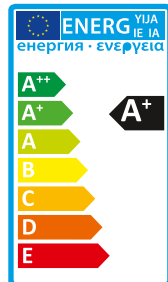

Montaje en aro de Ø50mm.
Suministrado con cable de 20cm.

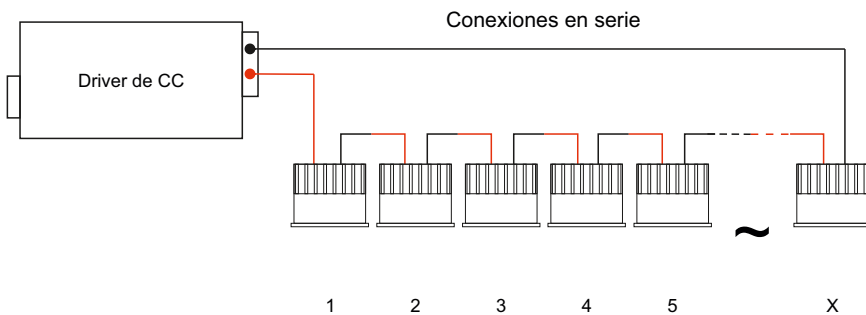
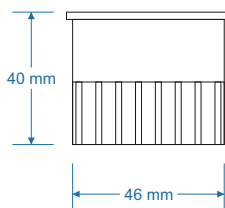
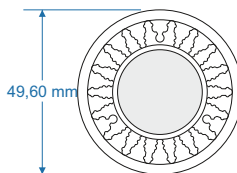

LÁMPARAS

REF.	V	I	W	#leds	Beam	Lumen	K
LEDTRIOTC/BF	~	350mA	1,25W	1	25°/45°	141Lm	5000°K
LEDTRIOTC/BC	~	350mA	1,25W	1	25°/45°	123Lm	3000°K
LEDTRIOTC/BN	~	350mA	1,25W	1	25°/45°	130Lm	4000°K

LEDTRIO / LEDTRIO POWER

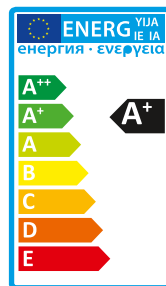

Montaje en aro de Ø50mm.
Suministrado con cable de 20cm.

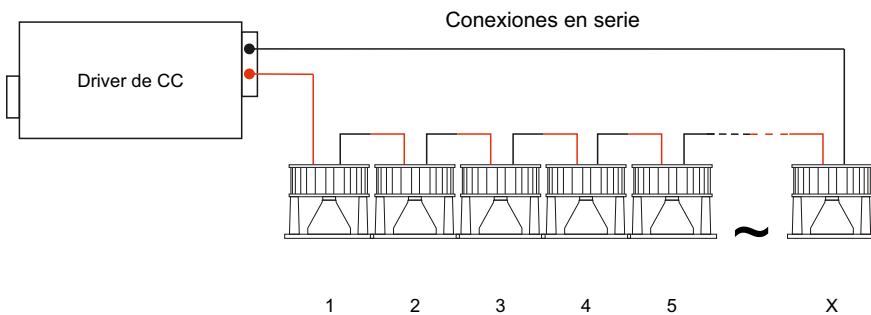
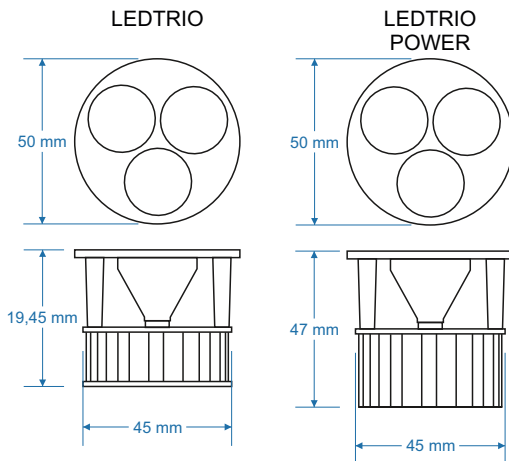

REF.	V	I	W	#leds	Beam	Lumen	K
LEDTRIO/BF	8,7Vcc	350mA	3,15W	3	10°/30°/45°	450Lm	5000°K
LEDTRIO/BC	8,7Vcc	350mA	3,15W	3	10°/30°/45°	370Lm	3000°K
LEDTRIO/BN	8,7Vcc	350mA	3,15W	3	10°/30°/45°	390Lm	4000°K
LEDTRIO/AZ	8,7Vcc	350mA	3,15W	3	10°/30°/45°	75Lm	/
LEDTRIO/V	8,7Vcc	350mA	3,15W	3	10°/30°/45°	270Lm	/
LEDTRIO/R	8,7Vcc	350mA	3,15W	3	10°/30°/45°	240Lm	/
REF.	V	I	W	#leds	Beam	Lumen	K
LEDTRIO P/BF	9,3Vcc	700mA	9W	3	10°/30°/45°	750Lm	5000°K
LEDTRIO P/BC	9,3Vcc	700mA	9W	3	10°/30°/45°	600Lm	3000°K
LEDTRIO P/BN	9,3Vcc	700mA	9W	3	10°/30°/45°	610Lm	4000°K
LEDTRIO P/AZ	9,3Vcc	700mA	9W	3	10°/30°/45°	150Lm	/
LEDTRIO P/V	9,3Vcc	700mA	9W	3	10°/30°/45°	540Lm	/
LEDTRIO P/R	9,3Vcc	700mA	9W	3	10°/30°/45°	480Lm	/

LÁMPARAS

LEDTRIOTC/RGB/12V

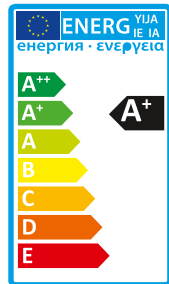

Montaje en aro de Ø50mm.
Suministrado con cable de 20cm.

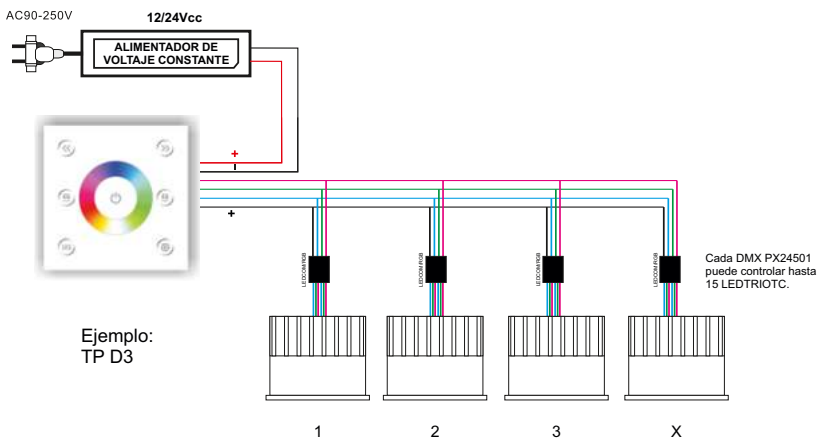
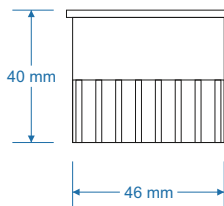
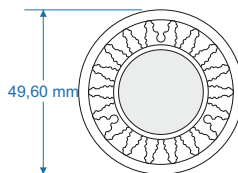

LÁMPARAS

REF.	V	I	W	#leds	Beam	Lumen	K
LEDTRIOTC/RGB/12	12/24Vcc	3x350mA	3,6W	1	25°/45°	~105Lm	5000°K

LEDTRIOTC/RGB

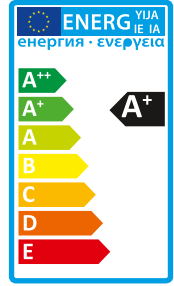

Montaje en aro de Ø50mm.
Suministrado con cable de 20cm.

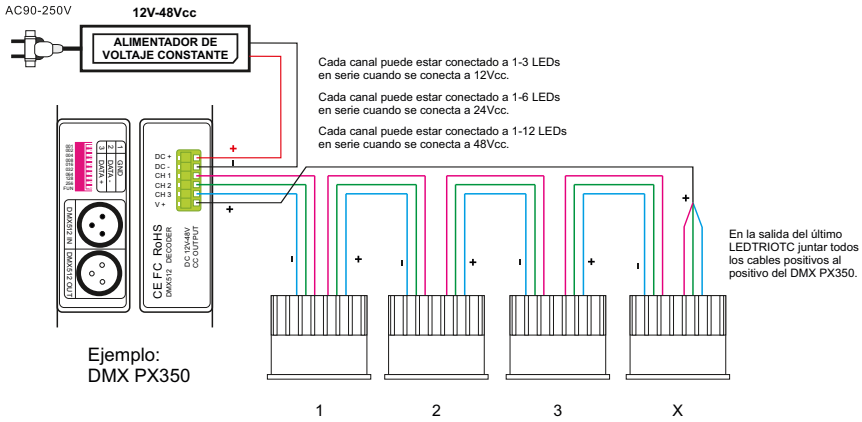
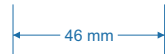
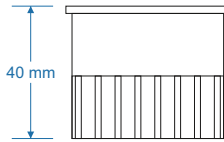
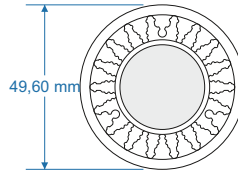

LÁMPARAS

REF.	V	I	W	#leds	Beam	Lumen	K
LEDTRIOTC/RGB	3,8Vcc	3x350mA	3,6W	1	25°/45°	~105lm	/

LEDTRIO/RGB/12V

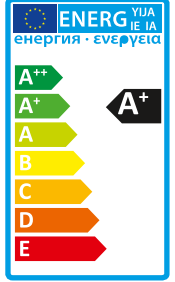

Montaje en aro de Ø50mm.
Suministrado con cable de 20cm.

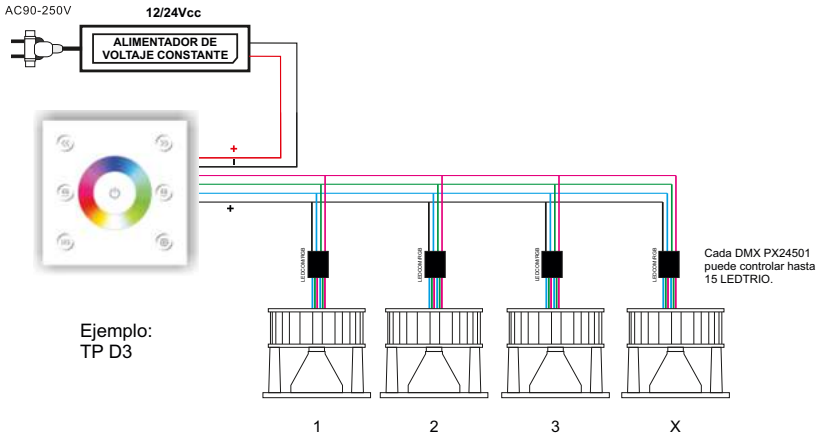
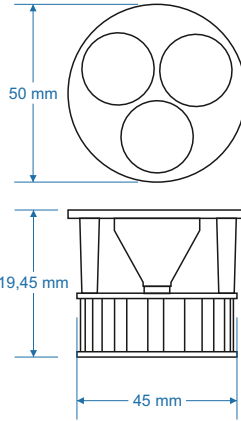

LÁMPARAS

REF.	V	I	W	#leds	Beam	Lumen	K
LEDTRIO/RGB/12	12/24Vcc	350mA	3,2W	3	30°/45°	~170Lm	/

LEDTRIO/RGB



Montaje en aro de Ø50mm.
Suministrado con cable de 20cm.

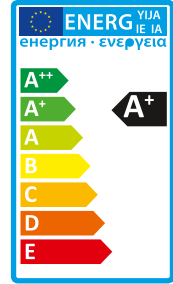
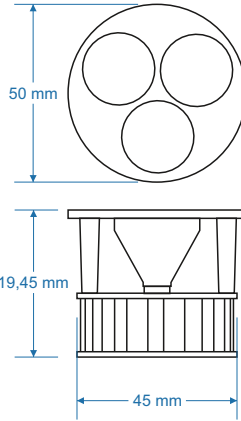

AC90-250V

12V-48Vcc

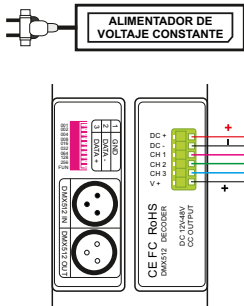

Ejemplo:
DMX PX350

Cada canal puede estar conectado a 1-3 LEDs en serie cuando se conecta a 12Vcc.

Cada canal puede estar conectado a 1-6 LEDs en serie cuando se conecta a 24Vcc.

Cada canal puede estar conectado a 1-12 LEDs en serie cuando se conecta a 48Vcc.

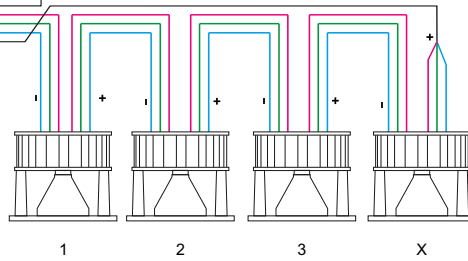

En la salida del último LEDTRIO/C juntar todos los cables positivos al positivo del DMX PX350.

LÁMPARAS

REF.	V	I	W	#leds	Beam	Lumen	K
LEDTRIO/RGB	3,2Vcc	350mA	3,2W	3	30°/45°	~170lm	/

LEDTRIOPOWER/RGB/V

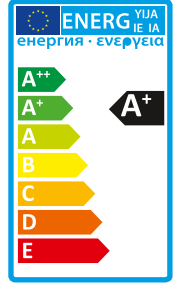

Montaje en aro de Ø50mm.
Suministrado con cable de 20cm.

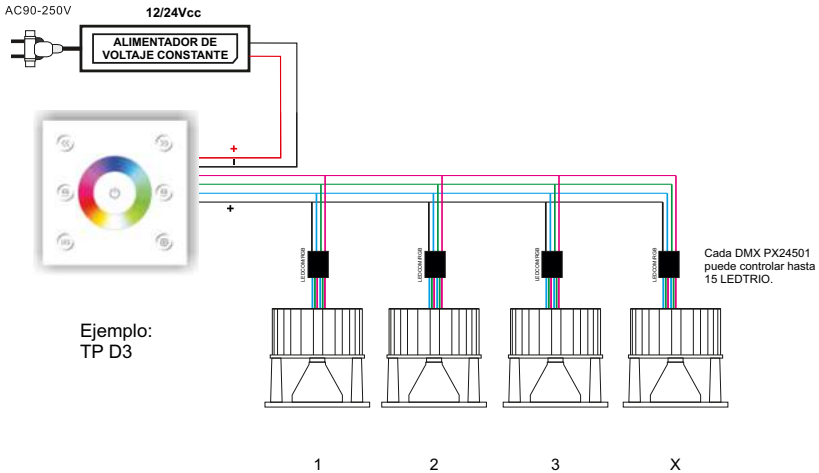
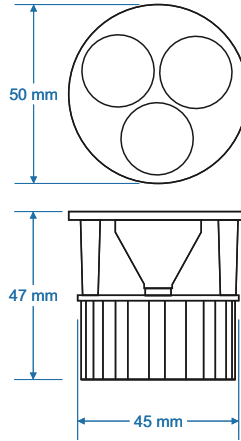

LÁMPARAS

REF.	V	I	W	#leds	Beam	Lumen	K
LEDTRIOPOWER/RGB/V	12/24Vcc	3x350mA	9W	3	30°/45°	~585Lm	/

LEDTRIOPOWER/RGB

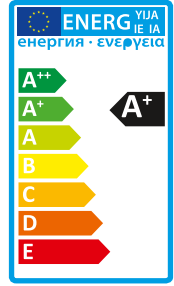
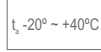

Montaje en aro de Ø50mm.
Suministrado con cable de 20cm.

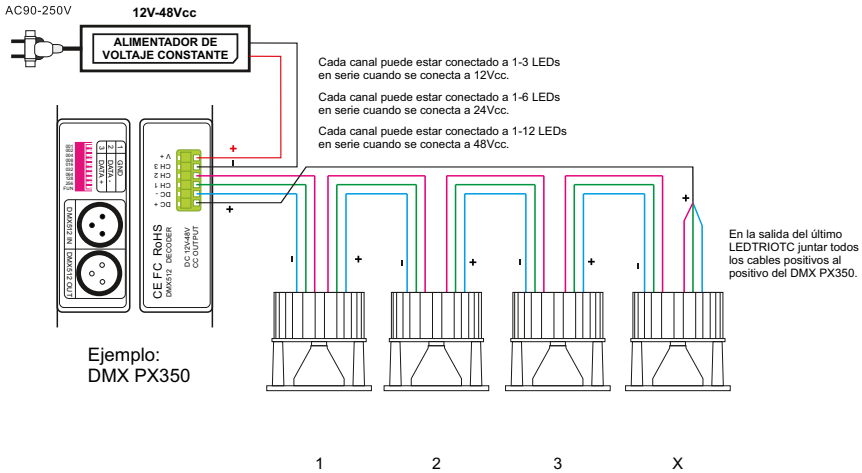
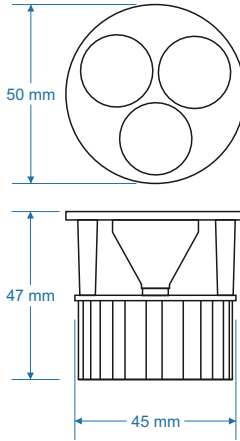

LÁMPARAS

REF.	V	I	W	#leds	Beam	Lumen	K
LEDTRIOP/RGB	11,5Vcc	3x350mA	9W	3	30°/45°	~585lm	/

U118

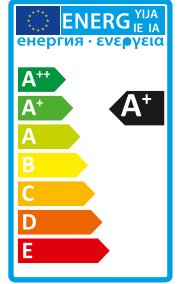

Montaje en aro de Ø110mm.
Suministrado con cable de 20cm.
Dimerizable de 0-24V.

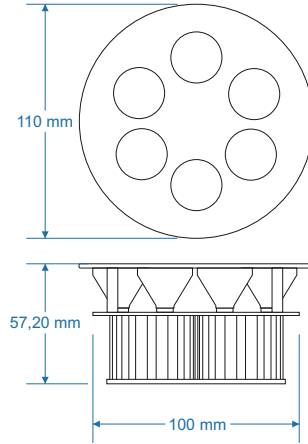
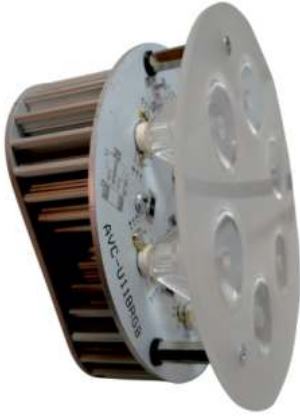

Dimmer
(opcional)

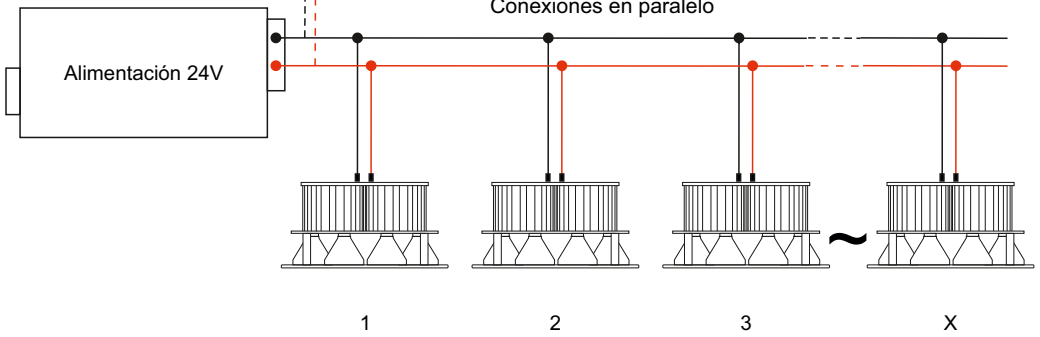
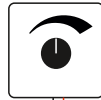

LÁMPARAS

REF.	V	I	W	#leds	Beam	Lumen	K
U118/BF	24Vcc	700mA	18W	6	15°/25°/40°	1750Lm	5000°K
U118/BC	24Vcc	700mA	18W	6	15°/25°/40°	1400Lm	3000°K
U118/BN	24Vcc	700mA	18W	6	15°/25°/40°	1421Lm	4000°K
U118/AZ	24Vcc	700mA	18W	6	15°/25°/40°	300Lm	/
U118/V	24Vcc	700mA	18W	6	15°/25°/40°	1080Lm	/
U118/R	24Vcc	700mA	18W	6	15°/25°/40°	960Lm	/

U118/RGB

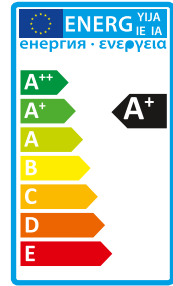

Montaje en aro de Ø110mm.
Suministrado con cable de 20cm.

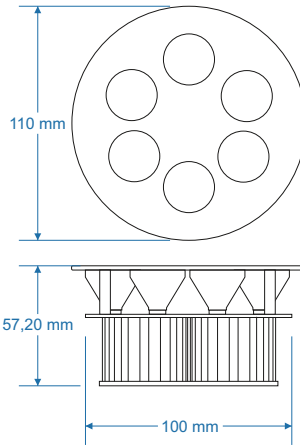
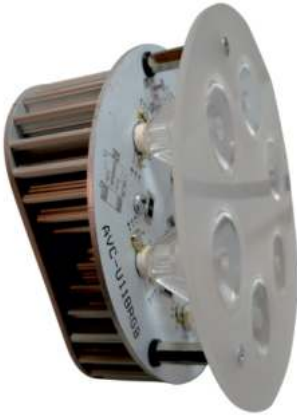

AC90-250V

24Vcc

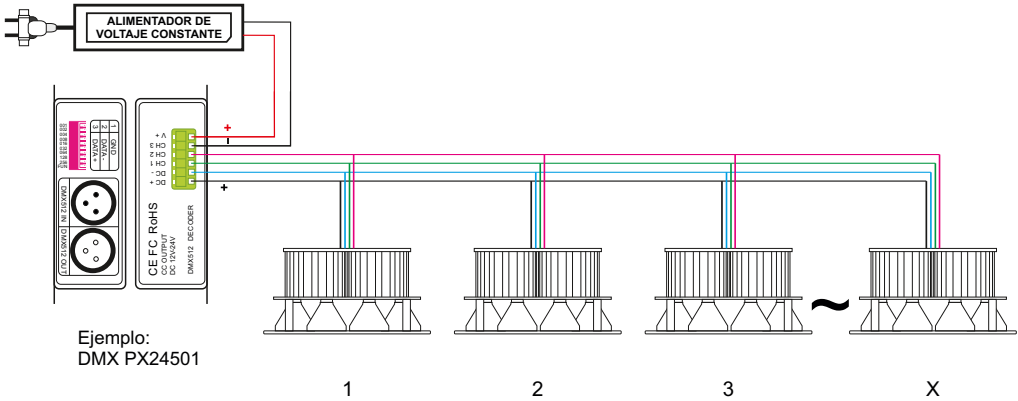

Ejemplo:
DMX PX24501

LÁMPARAS

REF.	V	I	W	#leds	Beam	Lumen	K
U118/RGB	24Vcc	3x350mA	18W	6	15°/25°/40°	~1170Lm	/

MI-FUT011

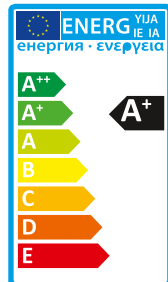

Lámpara GU10 para conexión directa a 220v.
Doble blanco CTO cálido/frío.

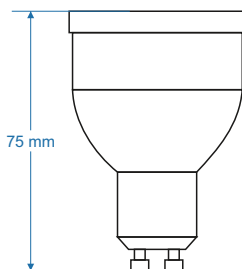
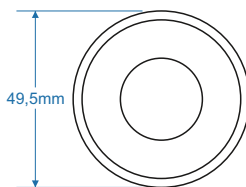

Ejemplo con MI-T2/MI-B2

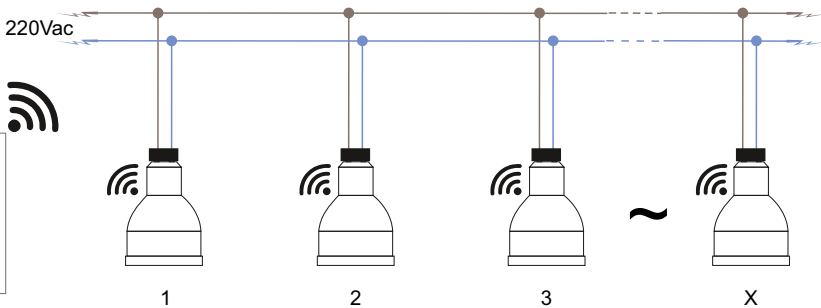
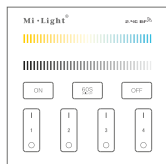

Consultar tabla de compatibilidad: pág 98

LÁMPARAS

REF.	V	IP	W	#leds	Beam	Lumen	K
MI-FUT011	220Vac	20	5W	6CW+6WW	30°	440-490lm	2700-6500°K

MI-FUT018

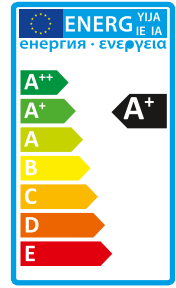

Lámpara GU10 para conexión directa a 220v.
RGB+W

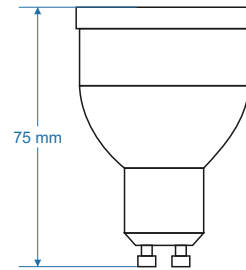
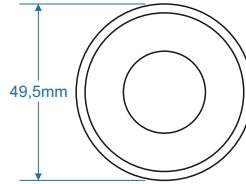

Ejemplo con
MI-RFRGBCTA

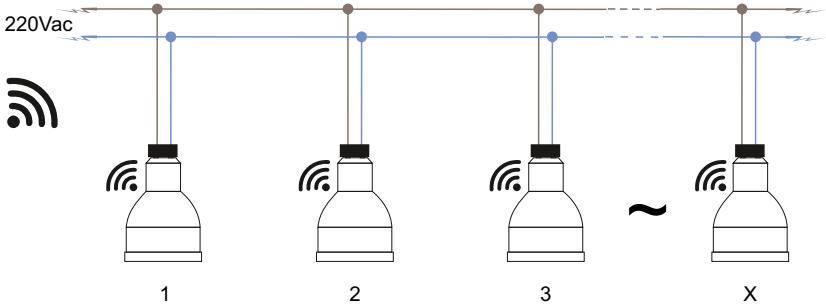

Consultar tabla de compatibilidad: pág 98

LÁMPARAS

REF.	V	IP	W	#leds	Beam	Lumen	K
MI-FUT018	220Vac	20	5W	6WW + 2RGB	30°	440~490Lm	/

MI-FUT019

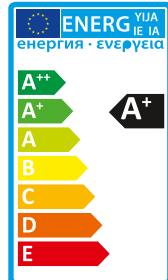

Lámpara E27 para conexión directa a 220v.
Doble blanco CTO cálido/frío.

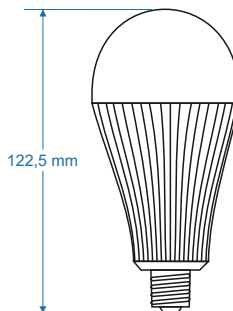
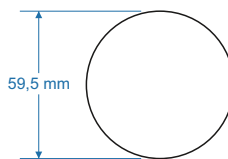

Ejemplo con
MI-RFCCT

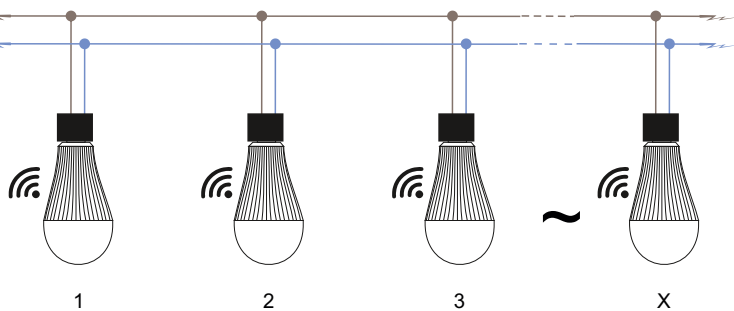

Consultar tabla de compatibilidad: pág 98

LÁMPARAS

REF.	V	IP	W	#leds	Beam	Lumen	K
MI-FUT019	220Vac	20	9W	10CW+10WW	180°	800-850Lm	2700-6500°K

MI-FUT016

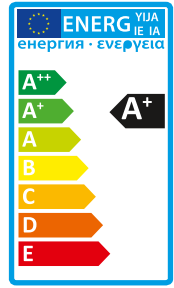

Lámpara E27 para conexión directa a 220v.
RGB+W

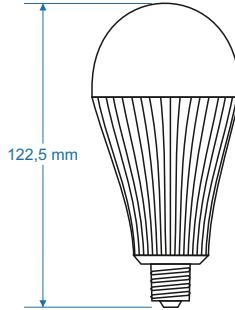
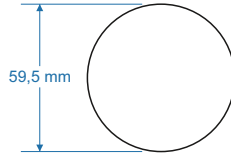

Ejemplo con
MI-RF2.4

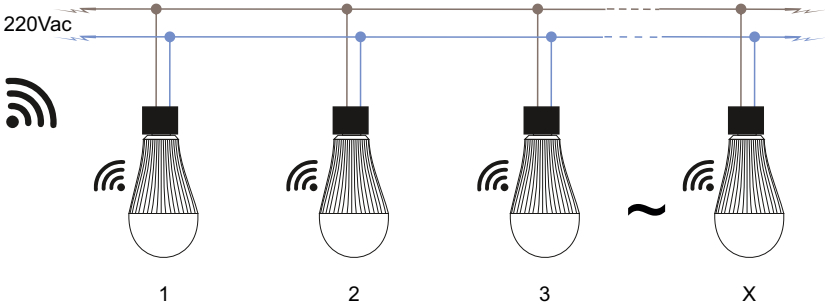

Consultar tabla de compatibilidad: pág 98

LÁMPARAS

REF.	V	IP	W	#leds	Beam	Lumen	K
FUT016	220Vac	20	9W	15WW + 4RGB	180°	800~850Lm	/

MI-FUTD03

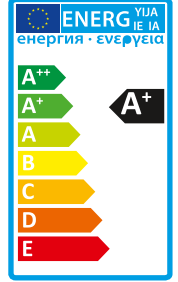

Lámpara E27 para conexión directa a 220v.
 RGB+CCT
 Controlable por DMX mediante antena MI-FUTD01.

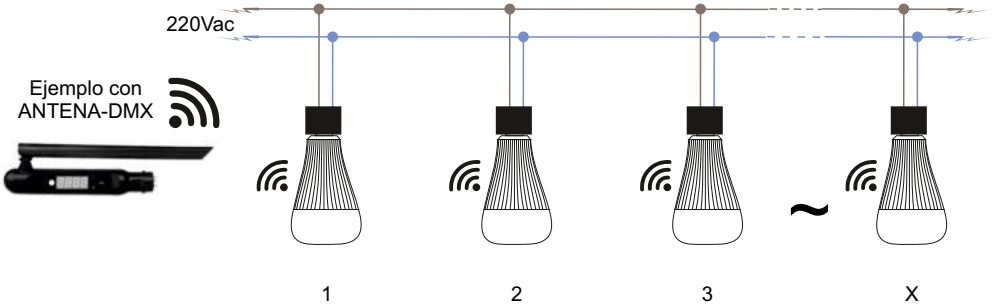
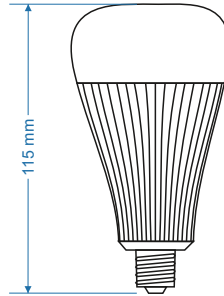
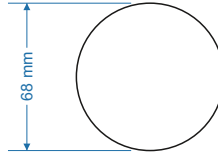

Consultar tabla de compatibilidad: pág 106

REF.	V	IP	W	#leds	Beam	Lumen	K
MI-FUTD03	220Vac	20	8W	CW+WW+RGB	220°	550Lm	-

LÁMPARAS

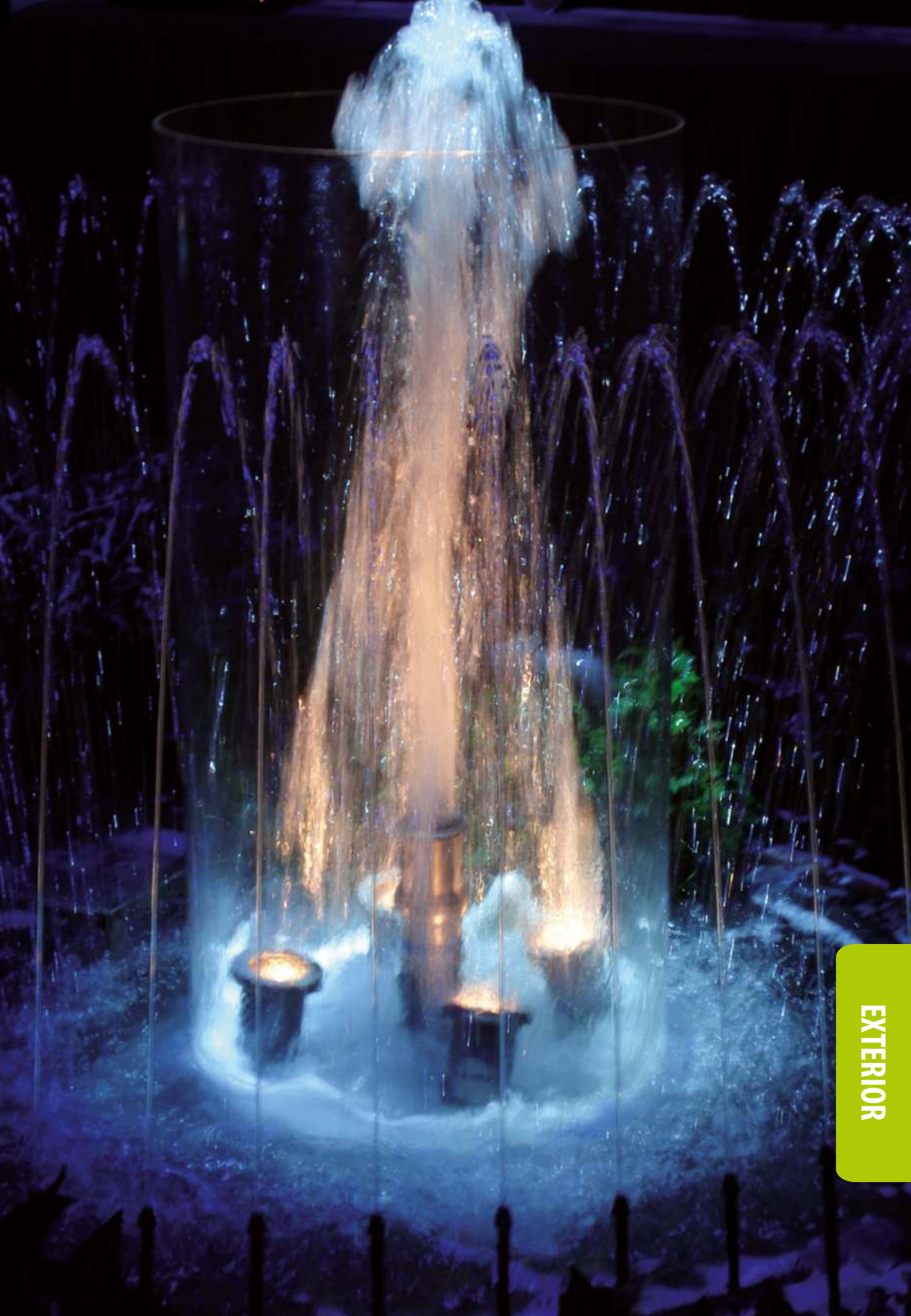

EXTERIOR

CMCOB

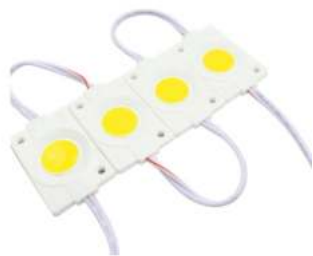

Modulos LED para rotulos.

Modulo led monocolor con 1 LED COB 3030.
Blanco cálido 3000°K y blanco frío 5000°K.
L44×An30×Al4(mm)

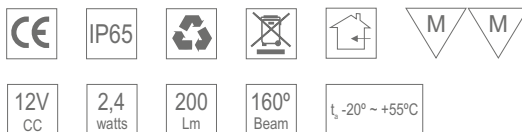

CMP1



Modulo led monocolor con 1 LED 1,5W.
Blanco cálido 3000°K y blanco frío 5000°K.
L40×An30×Al15(mm)

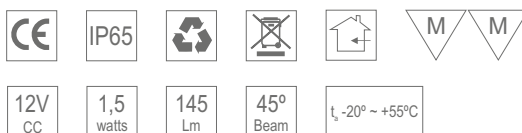

CM3



Modulo led monocolor con 3 LED SMD 5050.
Blanco frío 6000°K, blanco cálido 3000°K, Rojo, Verde, Azul y
Amarillo.
L68×An20×Al5(mm)

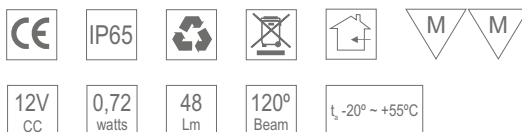

CM3/160



Modulo led monocolor con 3 LED SMD 2835 y lente de 160°.
Blanco frío 6000°K, blanco cálido 3000°K, Rojo, Verde, Azul y
Amarillo.
L68×An14×Al7,6(mm)

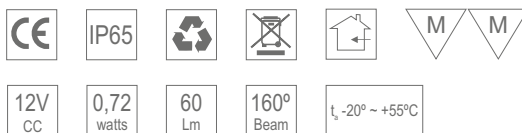

Ejemplo de instalación pág: 109

CMP3

Modulos LED para rotulos.

Modulo led monocolor con 3 LED SMD 5630.
 Blanco frío 6000°K, blanco cálido 3000°K, Rojo, Verde, Azul y
 Amarillo.
 L68×An20×Al5(mm)

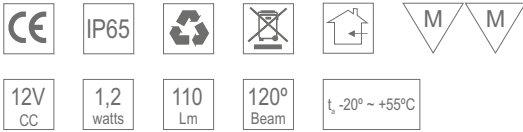

Ejemplo de instalación pág: 109

CM4

Modulo led monocolor con 4 LED SMD 5050.
 Blanco frío 6000°K, blanco cálido 3000°K, Rojo, Verde, Azul y
 Amarillo.
 L55×An33,5×Al6,5(mm)

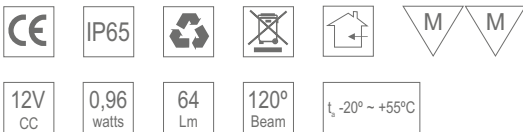

Ejemplo de instalación pág: 109

CMP4

Modulo led monocolor con 4 LED SMD 5630.
 Blanco frío 6000°K, blanco cálido 3000°K, Rojo, Verde, Azul y
 Amarillo.
 L55×An33,5×Al6,5(mm)

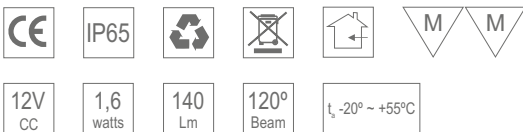

Ejemplo de instalación pág: 109

CM4/RGB

Modulo led RGB con 4 LED SMD 5050.
 L54,8×An33,2×Al5,9(mm)

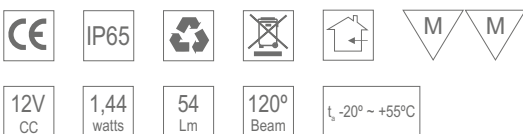

Ejemplo de instalación pág: 99

EXTERIOR

APL40/03

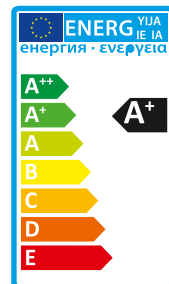

Montaje mediante tres puntos de anclaje en la base.
Protección IP65. Opción de sellado IP68.
Suministrado con cable de 20cm.

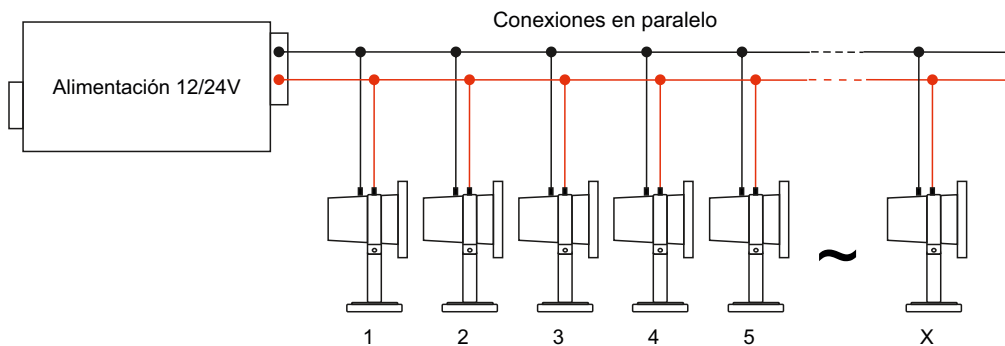
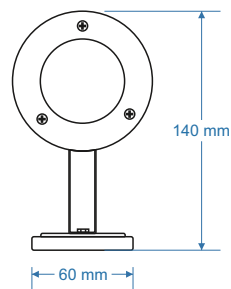
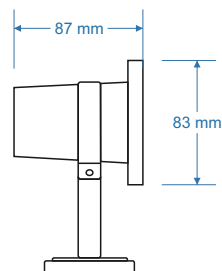

EXTERIOR

REF.	V	I	W	#leds	Beam	Lumen	K
APL40/03/BF	12/24Vcc	350mA	3W	3	10°/30°/45°	450Lm	5000°K
APL40/03/BC	12/24Vcc	350mA	3W	3	10°/30°/45°	370Lm	3000°K
APL40/03/BN	12/24Vcc	350mA	3W	3	10°/30°/45°	390Lm	4000°K
APL40/03/AZ	12/24Vcc	350mA	3W	3	10°/30°/45°	75Lm	/
APL40/03/V	12/24Vcc	350mA	3W	3	10°/30°/45°	270Lm	/
APL40/03/R	12/24Vcc	350mA	3W	3	10°/30°/45°	240Lm	/
APL40/03/BF/220V	220Vac	350mA	4W	4	38°	440Lm	5000°K
APL40/03/BC/220V	220Vac	350mA	4W	4	38°	320Lm	3000°K

APL40/03/RGB

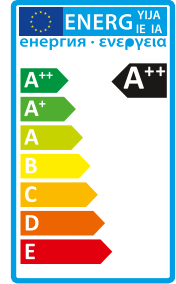

Montaje mediante tres puntos de anclaje en la base.
 Protección IP65. Opción de sellado IP68.
 Suministrado con cable de 20cm.

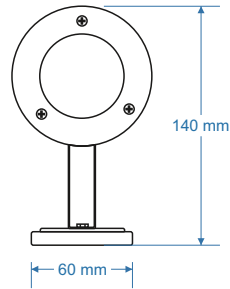
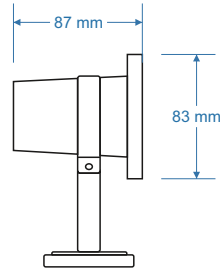

AC90-250V

12/24Vcc



Ejemplo:
TP D3

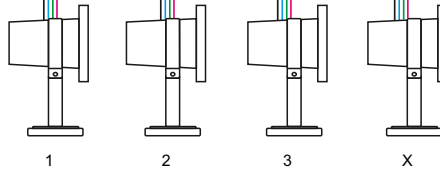

REF.	V	I	W	#leds	Beam	Lumen	K
APL40/03/RGB	12/24Vcc	350mA	3,2W	3	30°/45°	~170lm	/

EXTERIOR

APL40/09

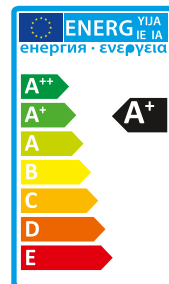

Montaje mediante tres puntos de anclaje en la base.
 Protección IP65. Opción de sellado IP68.
 Suministrado con cable de 20cm.

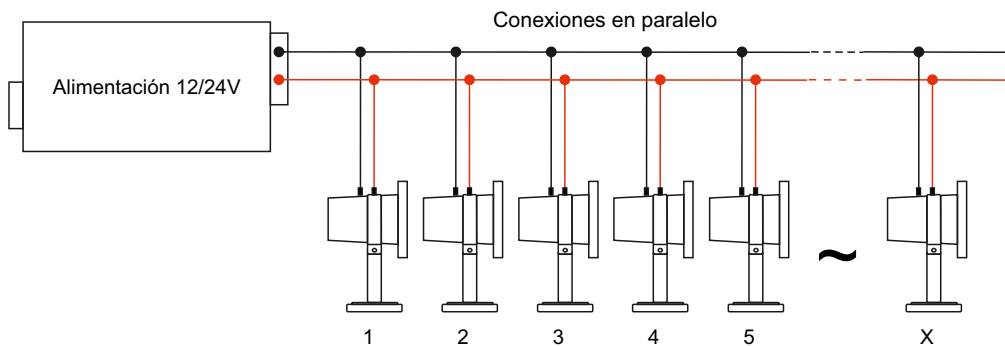
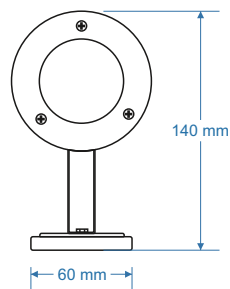
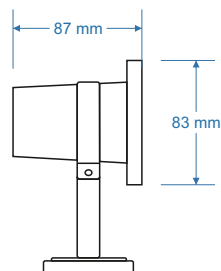

EXTERIOR

REF.	V	I	W	#leds	Beam	Lumen	K
APL40/09/BF	12/24Vcc	700mA	9W	3	10°/30°/45°	750Lm	5000°K
APL40/09/BC	12/24Vcc	700mA	9W	3	10°/30°/45°	600Lm	3000°K
APL40/09/BC	12/24Vcc	700mA	9W	3	10°/30°/45°	610Lm	3000°K
APL40/09/AZ	12/24Vcc	700mA	9W	3	10°/30°/45°	150Lm	/
APL40/09/V	12/24Vcc	700mA	9W	3	10°/30°/45°	540Lm	/
APL40/09/R	12/24Vcc	700mA	9W	3	10°/30°/45°	480Lm	/
APL40/09/BF/220V	220Vac	700mA	8W	1 COB	100°	700Lm	5000°K
APL40/09/BC/220V	220Vac	700mA	8W	1 COB	100°	590Lm	3000°K

APL40/09/RGB

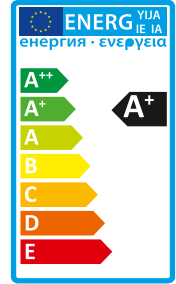

Montaje mediante tres puntos de anclaje en la base.
 Protección IP65. Opción de sellado IP68.
 Suministrado con cable de 20cm.

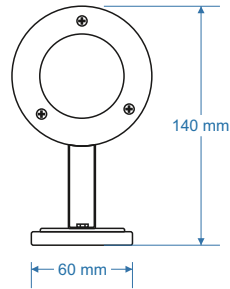
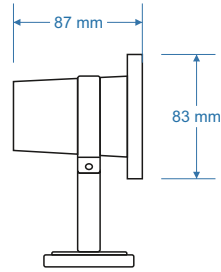

AC90-250V

12/24Vcc



Ejemplo:
TP D3

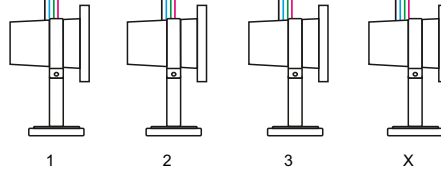

REF.	V	I	W	#leds	Beam	Lumen	K
APL40/03/RGB	12/24Vcc	3x350mA	9W	3	30°/45°	~585lm	/

EXTERIOR

APL40/15

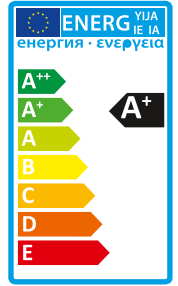

Montaje mediante tres puntos de anclaje en la base.
 Protección IP65. Opción de sellado IP68.
 Suministrado con cable de 20cm.

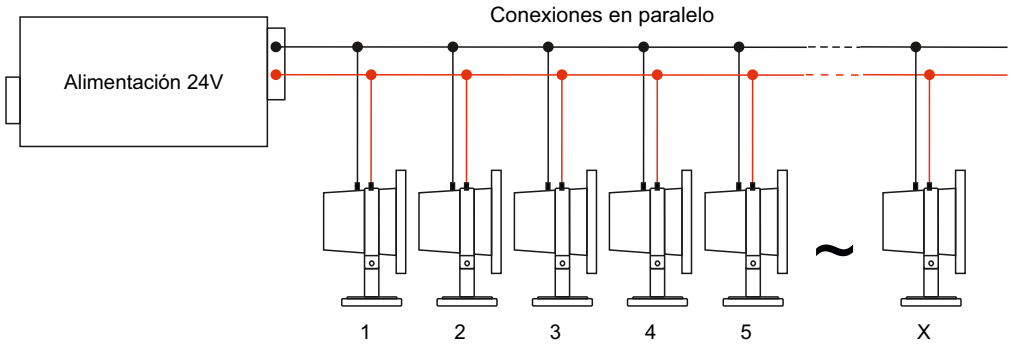
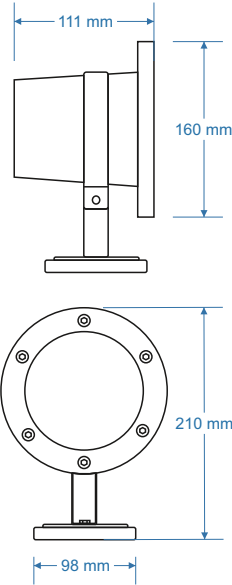

EXTERIOR

REF.	V	I	W	#leds	Beam	Lumen	K
APL40/15/BF	24Vcc	700mA	18W	6	15°/25°/40°	1750Lm	5000°K
APL40/15/BC	24Vcc	700mA	18W	6	15°/25°/40°	1400Lm	3000°K
APL40/15/BN	24Vcc	700mA	18W	6	15°/25°/40°	1421Lm	4000°K
APL40/15/AZ	24Vcc	700mA	18W	6	15°/25°/40°	300Lm	/
APL40/15/V	24Vcc	700mA	18W	6	15°/25°/40°	1080Lm	/
APL40/15/R	24Vcc	700mA	18W	6	15°/25°/40°	960Lm	/

APL40/15/RGB

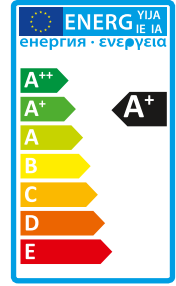

Montaje mediante tres puntos de anclaje en la base.
 Protección IP65. Opción de sellado IP68.
 Suministrado con cable de 20cm.

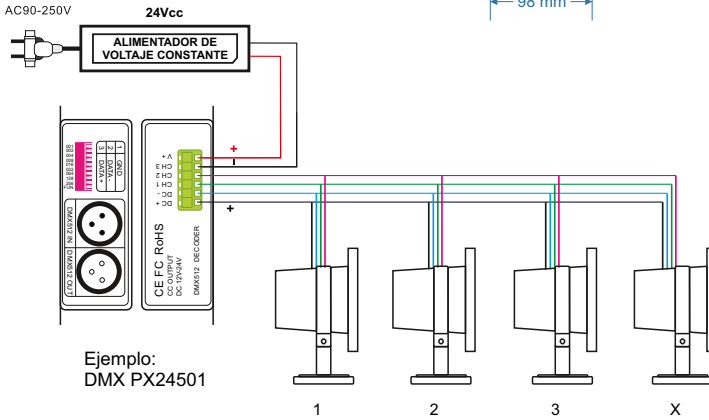
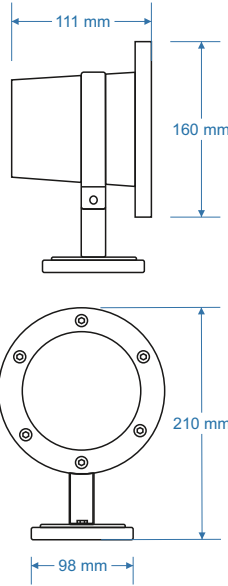

REF.	V	I	W	#leds	Beam	Lumen	K
APL40/15/RGB	24Vcc	3x350mA	18W	6	15°/25°/40°	~1170Lm	/

EXTERIOR

LEDPAR56



Montaje mediante nicho empotrable.
Requiere de instalación subacuática.

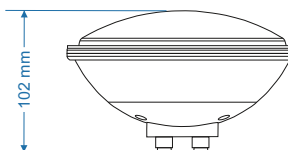
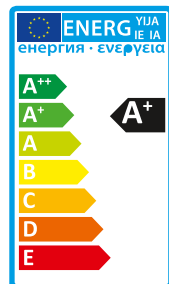
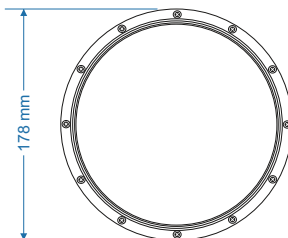

Blanco:

Conexiones en paralelo

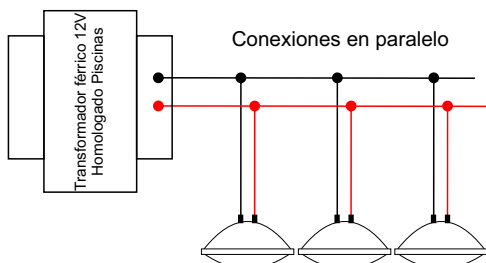

RGB:

Conexiones en paralelo

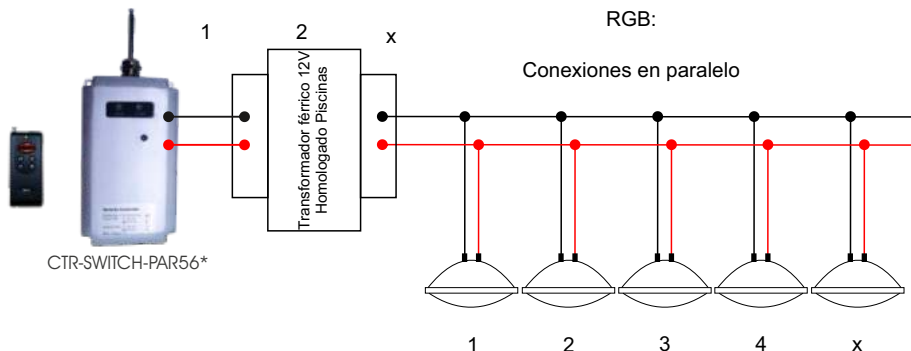

EXTERIOR

REF.	V	IP	W	#leds	Beam	Lumen	K
LEDPAR56/BL	12Vac	68	22W	18	120°	1290Lm	6000°K
LEDPAR56/RGB	12Vac	68	22W	18	120°	/	/

REF.	V	IP	W	#lamps	RF	Control
CTR-SWITCH-PAR56* 220Vac		65	1000W	max 50 LEDPAR	433Mhz	máx 30m

*Exclusivo para LEDPAR56/RGB.

LEDPAR56/S



Montaje en superficie.
Requiere de instalación subacuática.

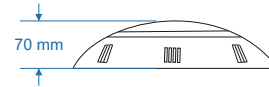
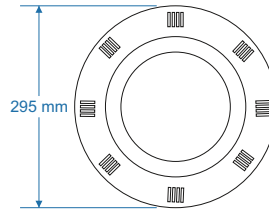
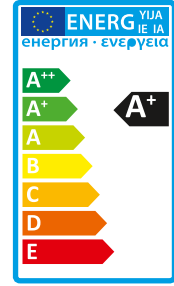

Blanco:

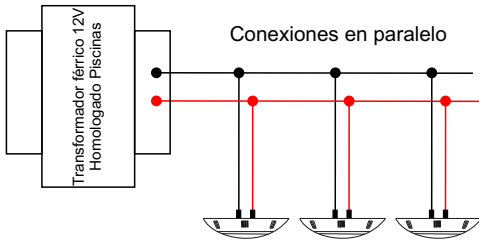

Conexiones en paralelo

102 mm

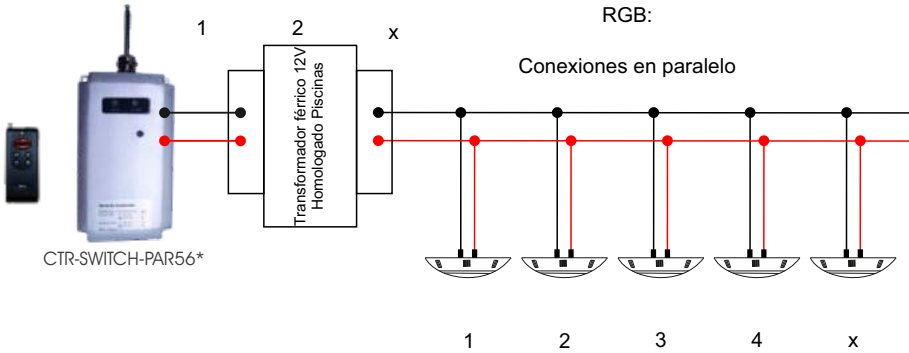

RGB:

Conexiones en paralelo

1 2 3 4 x

REF.	V	IP	W	#leds	Beam	Lumen	K
LEDPAR56/S/BF	12Vac	68	18W	18	120°	/	5000°K
LEDPAR56/S/RGB	12Vac	68	18W	18	120°	/	/

REF.	V	IP	W	#lamps	RF	Control
CTR-SWITCH-PAR56*	220Vac	65	1000W	max 50 LEDPAR	433Mhz	máx 30m

*Exclusivo para LEDPAR56/S/RGB.

EXTERIOR

APL41/01

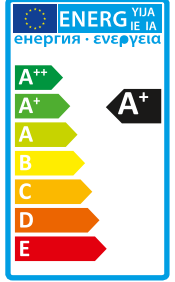

Montaje a presión mediante vaso de empotrar Ø30mm.
Cristal templado resistente a las pisadas.
Suministrado con cable de 20cm.

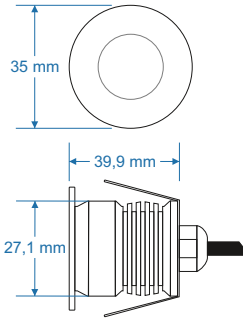

Accesorio para empotrar

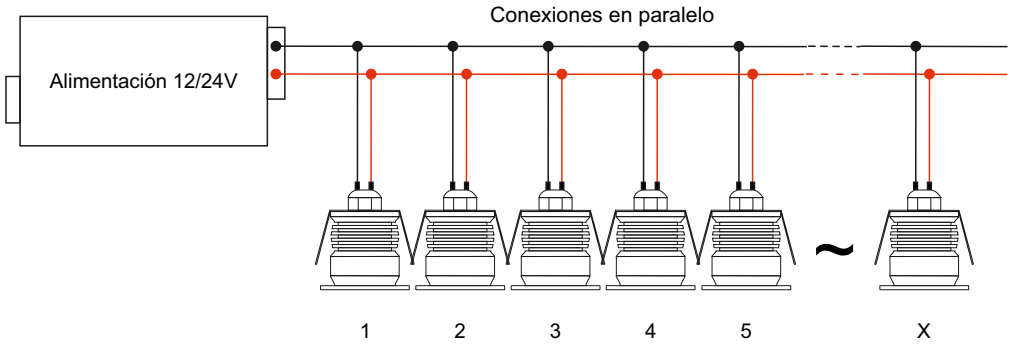
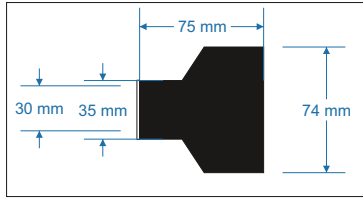

EXTERIOR

REF.	V	IP	W	#leds	Beam	Lumen	K
APL41/01/BF	12/24Vcc	67	1W	1	15°/45°/60°	95Lm	6000°K
APL41/01/BC	12/24Vcc	67	1W	1	15°/45°/60°	87Lm	3000°K
APL41/01/BN	12/24Vcc	67	1W	1	15°/45°/60°	90Lm	4000°K

APL41/01

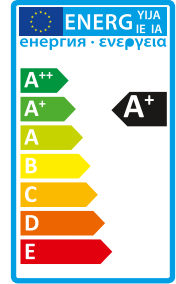

Montaje a presión mediante vaso de empstrar Ø30mm.
Cristal templado resistente a las pisadas.
Suministrado con cable de 20cm.

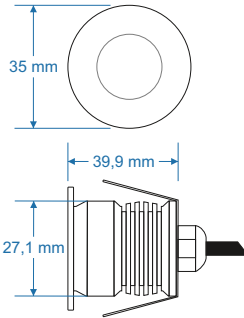

Accesorio para empstrar

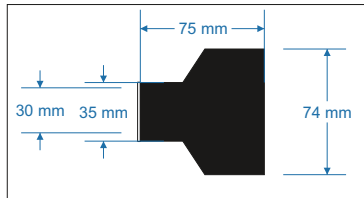

Conexiones en paralelo

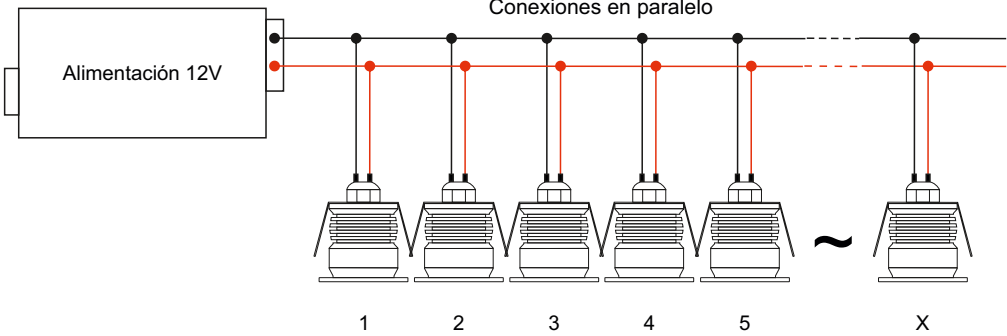

REF.	V	IP	W	#leds	Beam	Lumen	K
APL41/01/BF	12/24Vcc	67	1W	1	15°/30°/60°	95Lm	5000°K
APL41/01/BC	12/24Vcc	67	1W	1	15°/30°/60°	87Lm	3000°K
APL41/01/BN	12/24Vcc	67	1W	1	15°/30°/60°	90Lm	4000°K

EXTERIOR

APL41/09

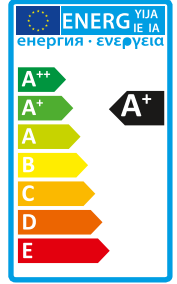

Montaje mediante vaso de empotrar Ø103mm.
Cristal templado resistente a las pisadas.
Suministrado con cable de 20cm.

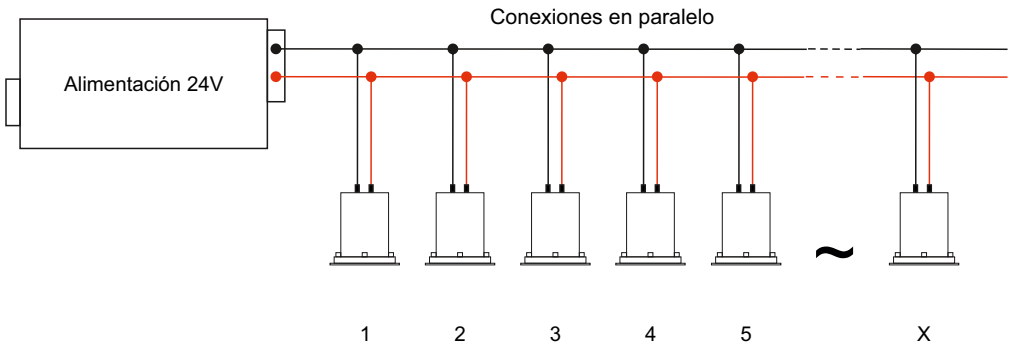
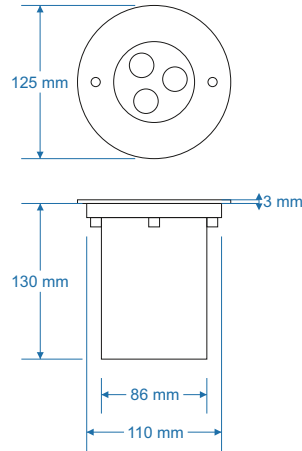

EXTERIOR

REF.	V	I	W	#leds	Beam	Lumen	K
APL41/09/BF	24Vcc	700mA	9W	3	10°/30°/45°	750Lm	6000°K
APL41/09/BC	24Vcc	700mA	9W	3	10°/30°/45°	600Lm	3000°K

APL41/09/RGB



IP65



CRI>80

t_a -20° ~ +40°C

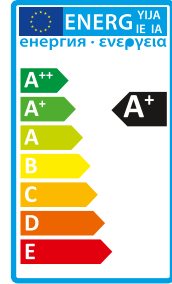

Montaje mediante vaso de empotrar Ø103mm.
Cristal templado resistente a las pisadas.
Suministrado con cable de 20cm.

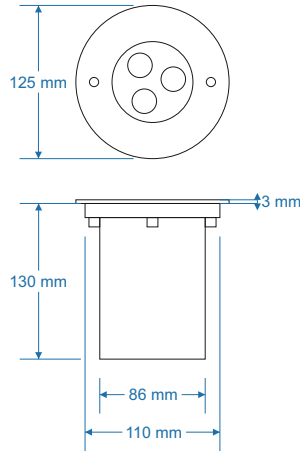

AC90-250V

24Vcc



Ejemplo:
TP D3

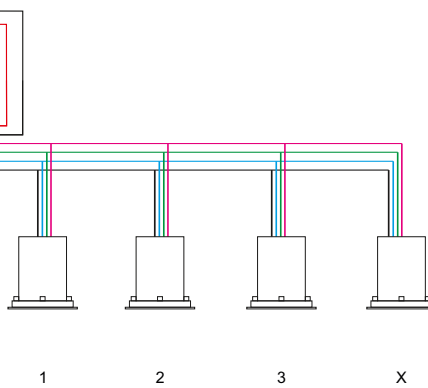

REF.	V	I	W	#leds	Beam	Lumen	K
APL41/09/RGB	24Vcc	3x350mA	9W	3	10°/30°/45°	~585Lm	/

EXTERIOR

APL41/18

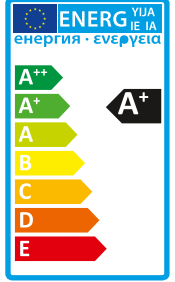

Montaje mediante vaso de empotrar Ø162mm.
Cristal templado resistente a las pisadas.
Suministrado con cable de 20cm.

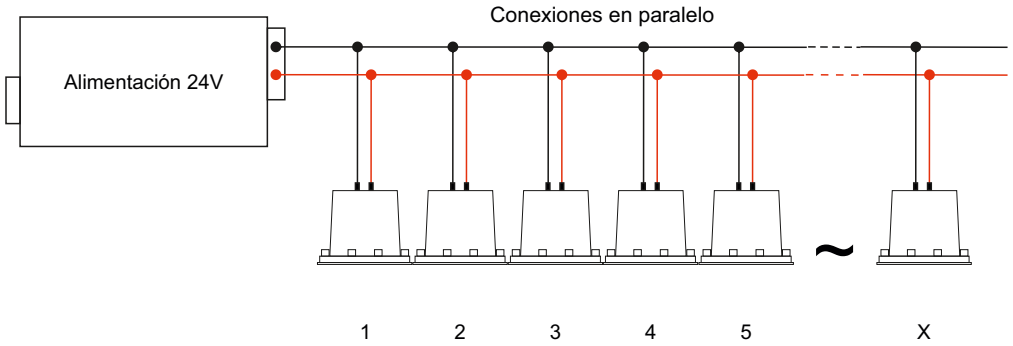
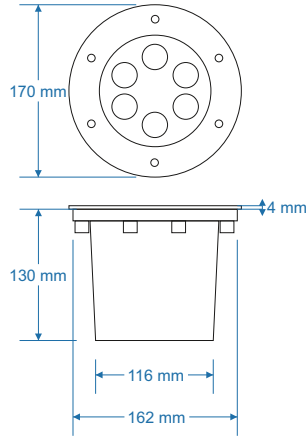

EXTERIOR

REF.	V	I	W	#leds	Beam	Lumen	K
APL41/18/BF	24Vcc	700mA	18W	6	15°/25°/40°	1750Lm	5000°K
APL41/18/BC	24Vcc	700mA	18W	6	15°/25°/40°	1400Lm	3000°K
APL41/18/BN	24Vcc	700mA	18W	6	15°/25°/40°	1421Lm	4000°K
APL41/18/AZ	24Vcc	700mA	18W	6	15°/25°/40°	300Lm	/
APL41/18/V	24Vcc	700mA	18W	6	15°/25°/40°	1080Lm	/
APL41/18/R	24Vcc	700mA	18W	6	15°/25°/40°	960Lm	/

APL41/18/RGB



IP65



CRI>80

t_a -20° ~ +40°C

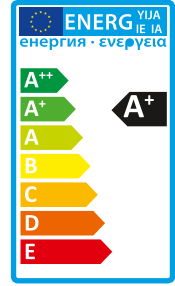

Montaje mediante vaso de empotrar Ø162mm.
Cristal templado resistente a las pisadas.
Suministrado con cable de 20cm.

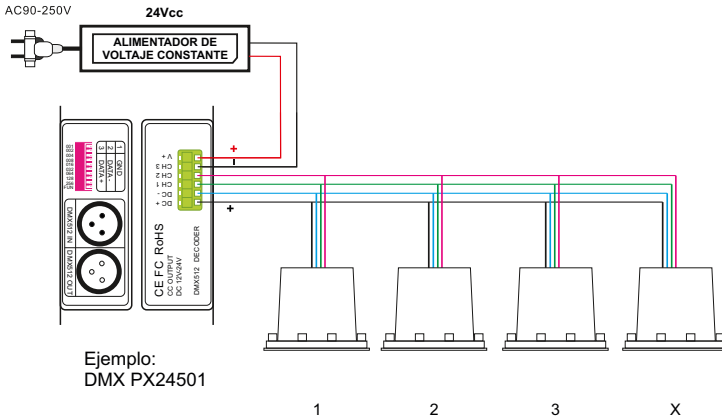
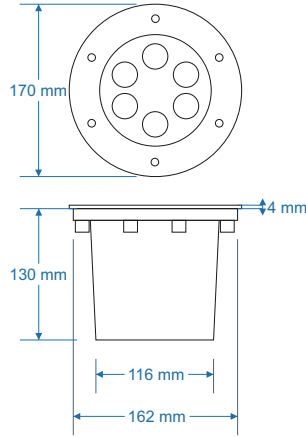

REF.	V	I	W	#leds	Beam	Lumen	K
APL41/18/RGB	24Vcc	3x350mA	18W	6	15°/25°/40°	~1170Lm	/

EXTERIOR

Serie TP-D

Diagrama de cableado del TP D1:



Diagrama de cableado del TP D2:



Diagrama de cableado del TP D3:

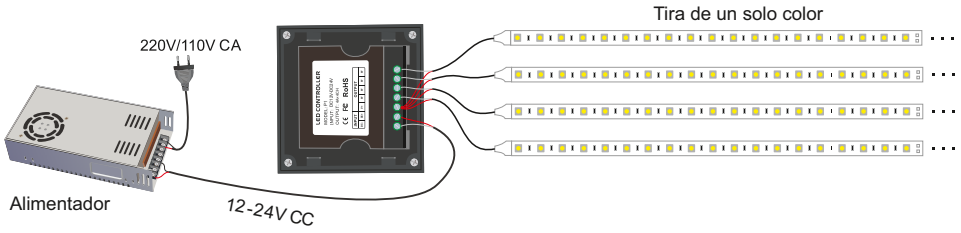

Diagrama de cableado del TP D4:

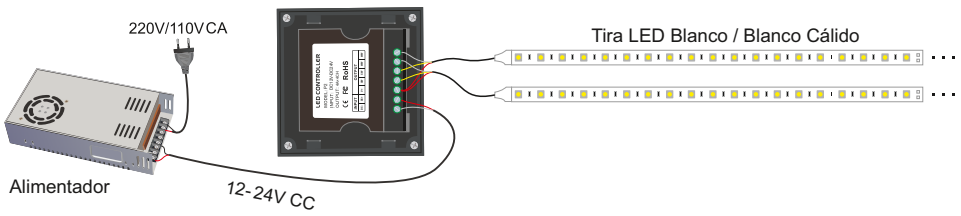

Conexionado:

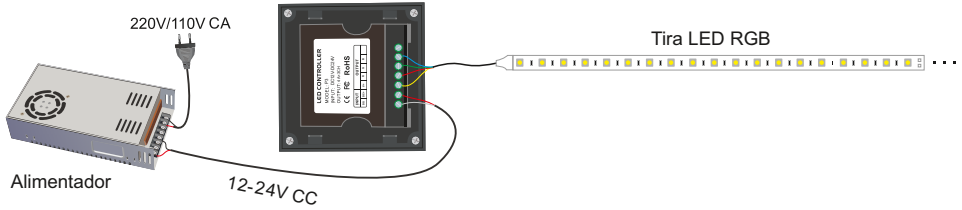
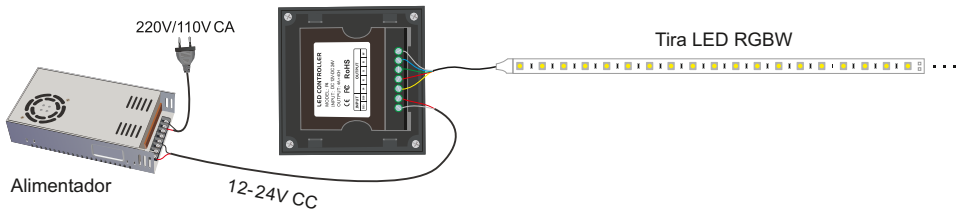
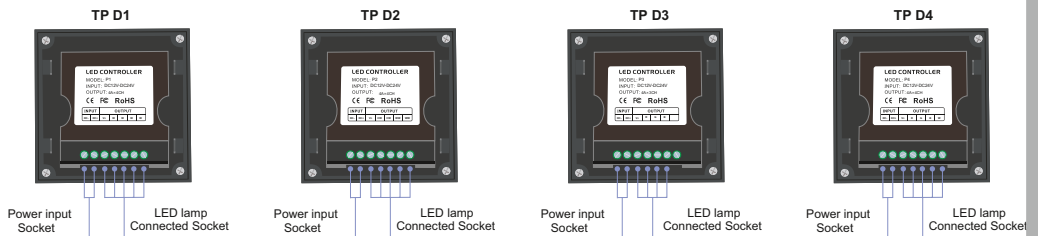

Serie TP-X

La serie TP-X sigue el standard DMX y puede funcionar con cualquier controlador compatible con DMX y con receptores propios inalámbricos simultáneamente.

Ejemplo de instalación: TP 8X

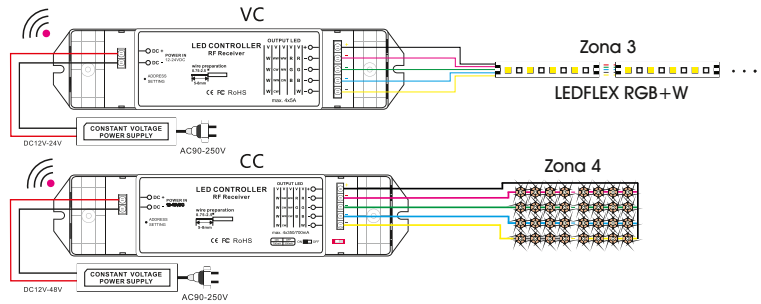
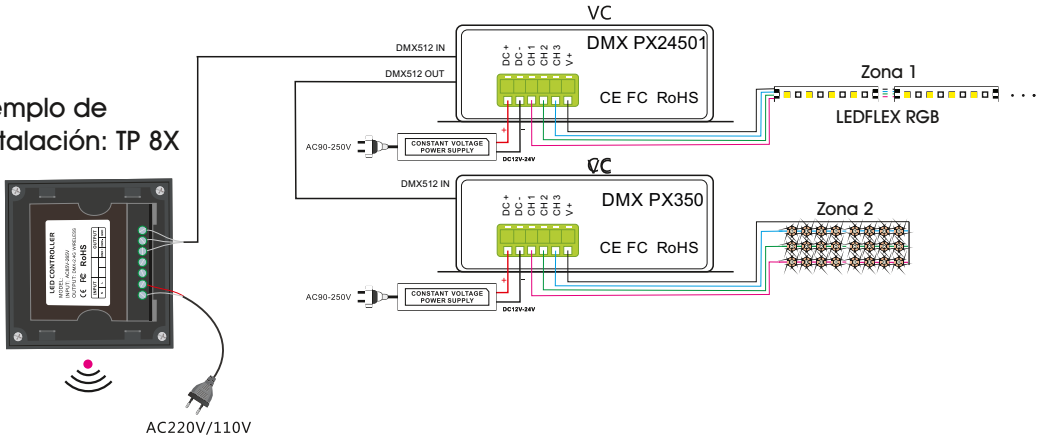

Conexión:

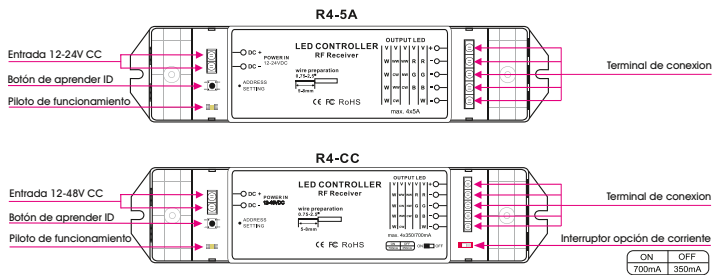

SLESA - STICK

Todos los modelos SLESA y STICK se pueden programar mediante ordenador para realizar escenas complejas de iluminación arquitectónica.

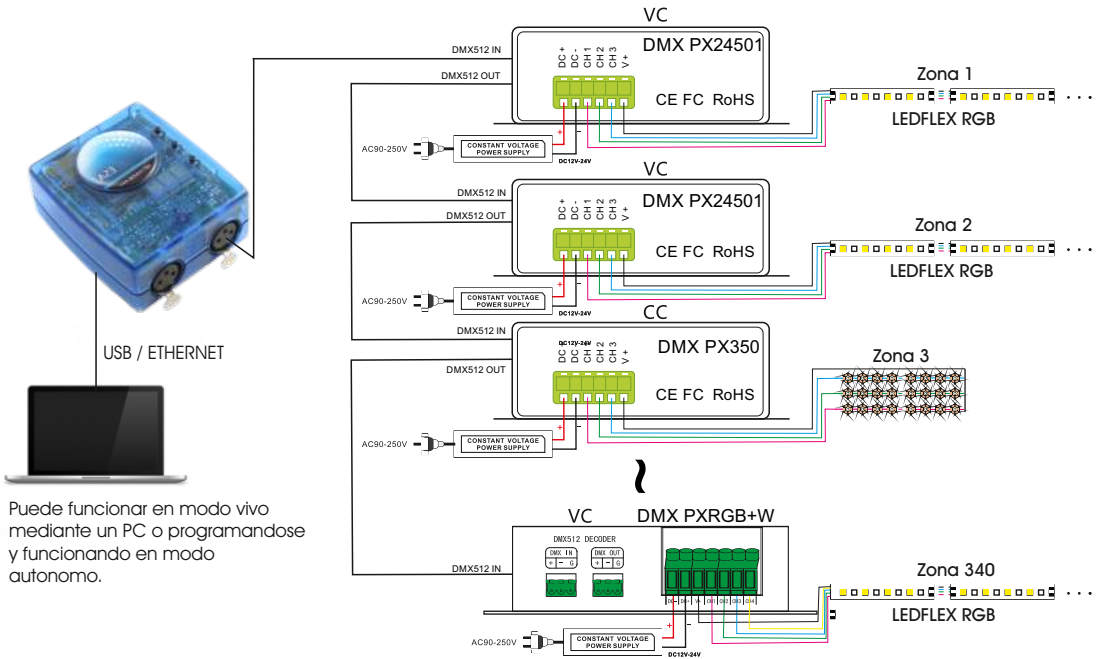

Puede funcionar en modo vivo mediante un PC o programandose y funcionando en modo autonomo.

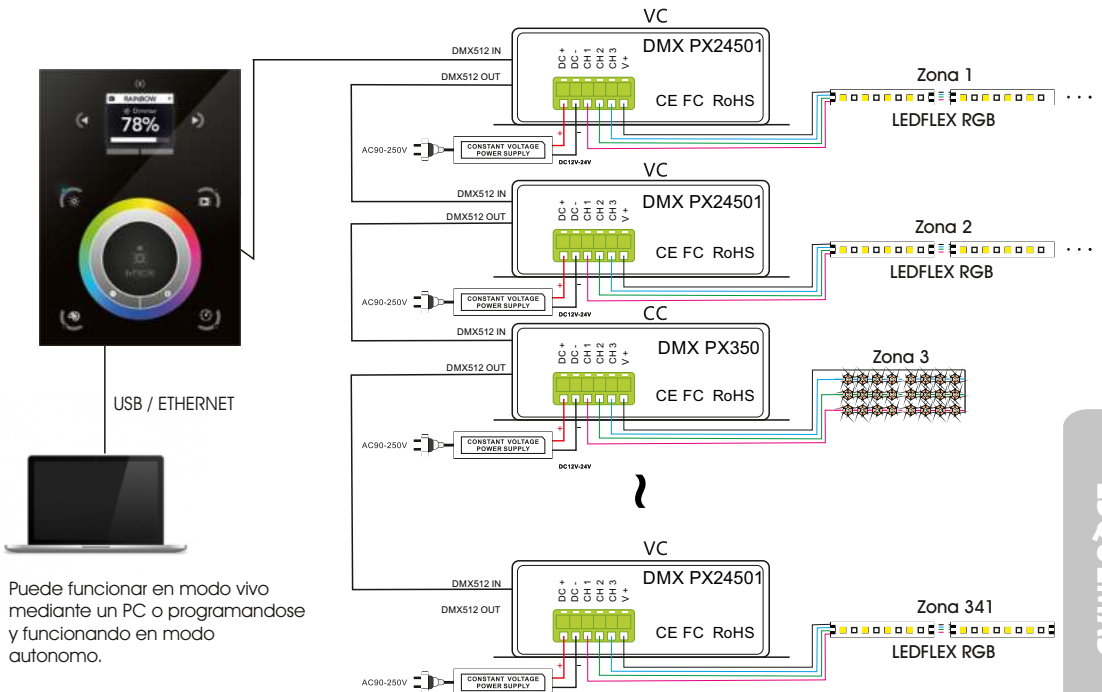

Puede funcionar en modo vivo mediante un PC o programandose y funcionando en modo autonomo.

WDIMMER

Ejemplo de instalación: WDIMMER / HC100

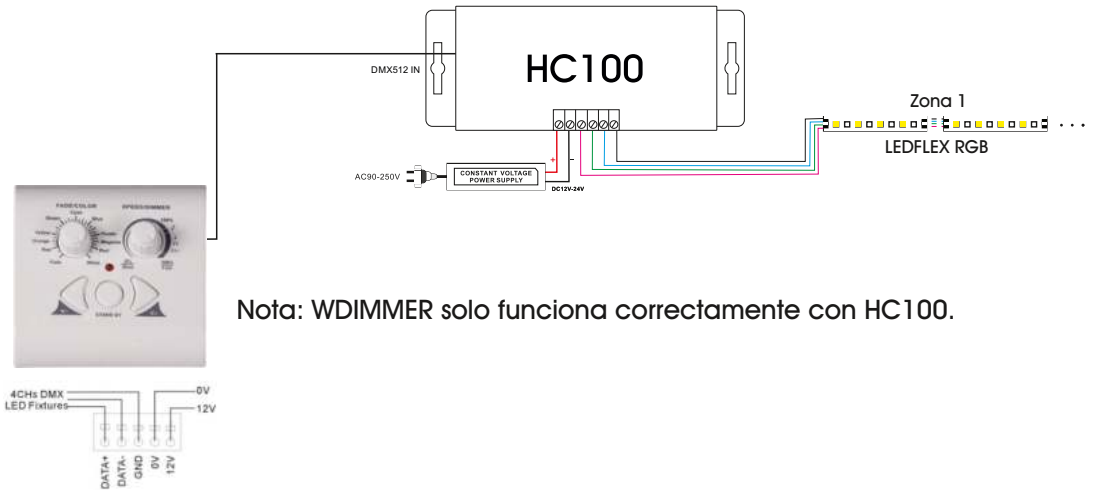

Nota: WDIMMER solo funciona correctamente con HC100.

Ejemplo de instalación: WDIMMER6 + OPCIÓN: DMX SPLITTER.

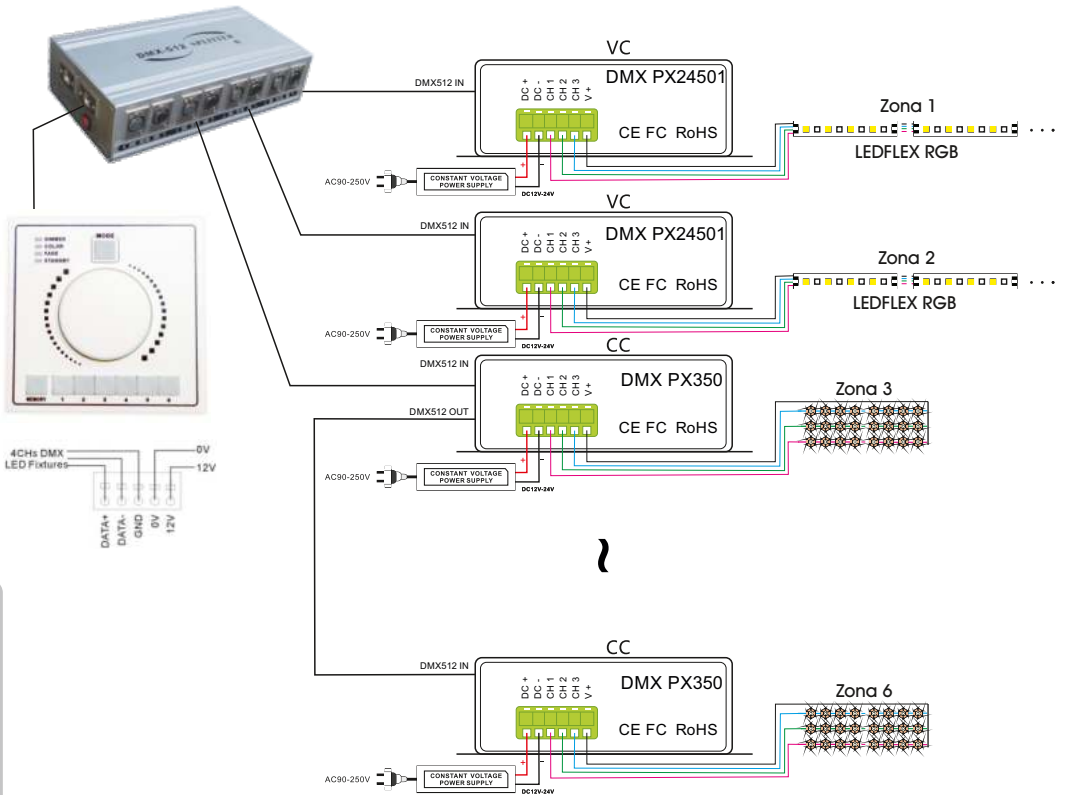

Ejemplo de instalación: MI-RF2.1

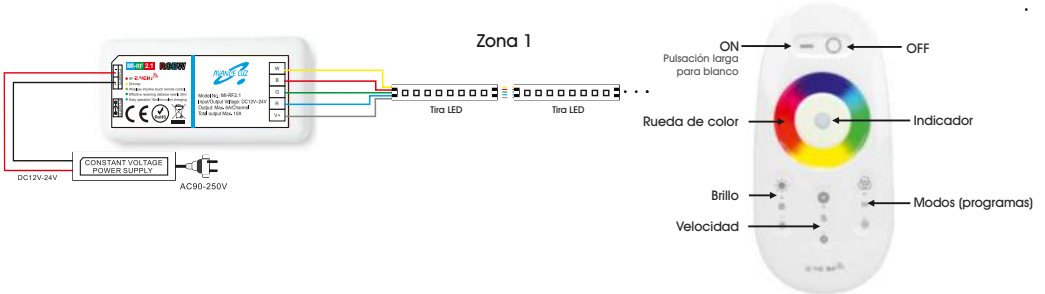

Ejemplo de instalación: MI-BT2.4

Se pueden enlazar hasta 4 x MI-BT2.4 desde la APP y controlarlos independientemente o de forma simultanea.

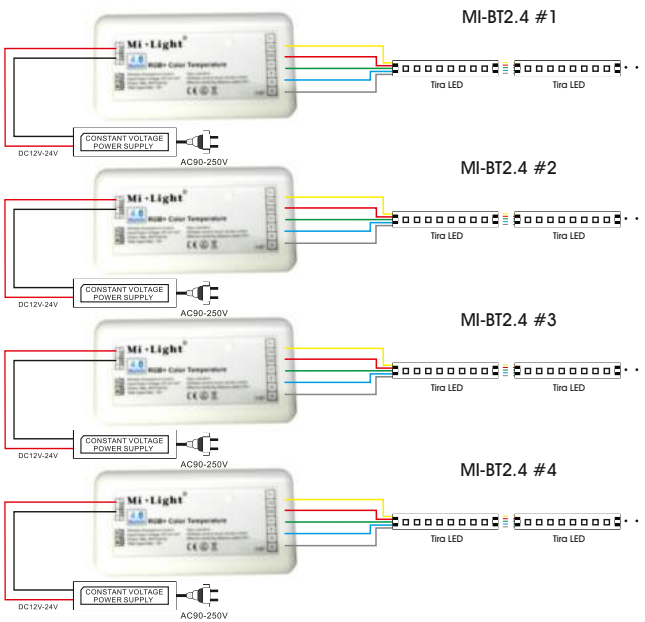

AMPLILED

Ejemplo de instalación con diferentes amplileds a partir de una señal de corriente constante. De cada ampliled se pueden conectar otros amplileds como sean necesarios sin ningún límite.

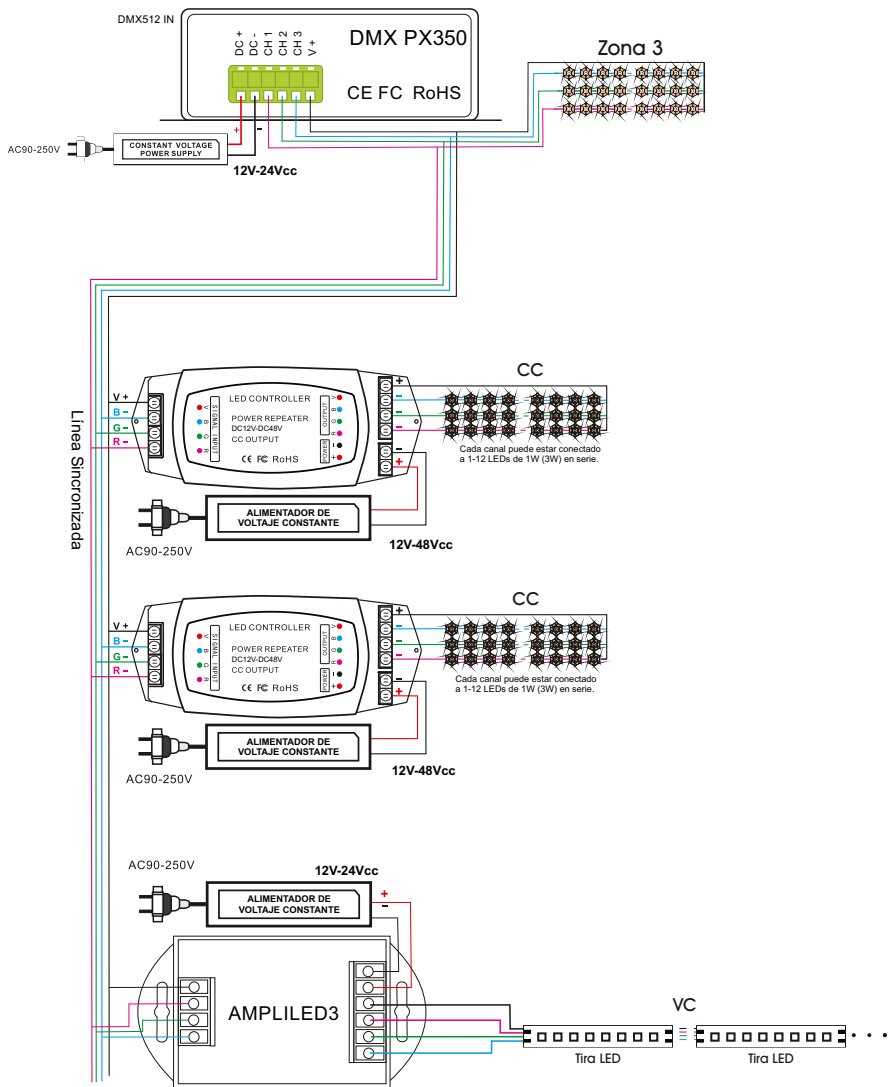

LEDCOM / LEDCOM-RGB

Ejemplo de instalación: LEDCOM

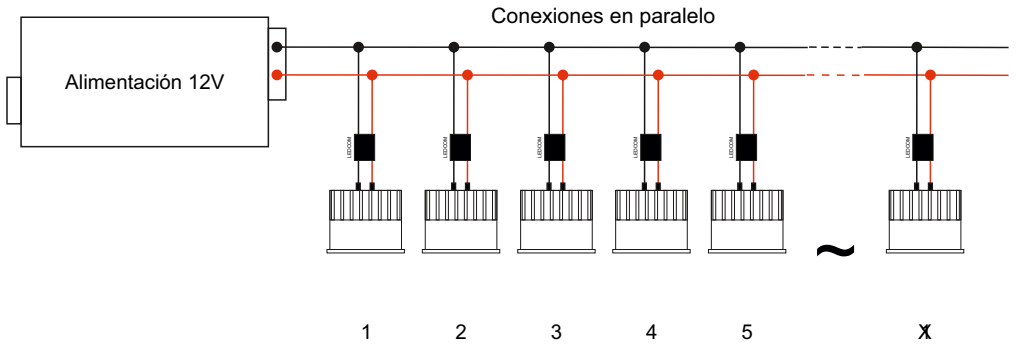

Ejemplo de instalación: LEDCOM RGB

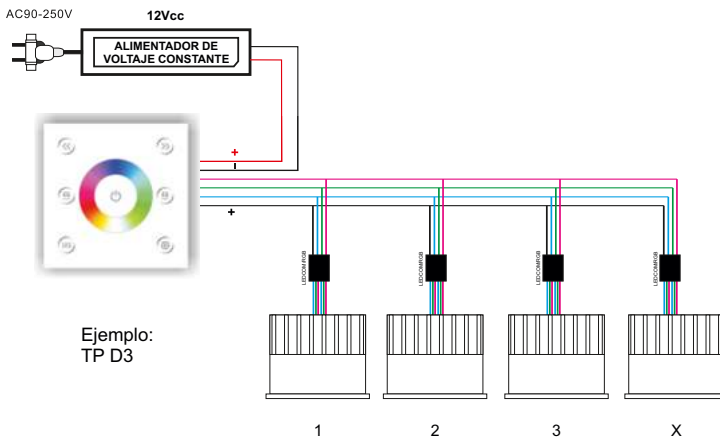

DRIVERS CC

Ejemplo de instalación: BULL350

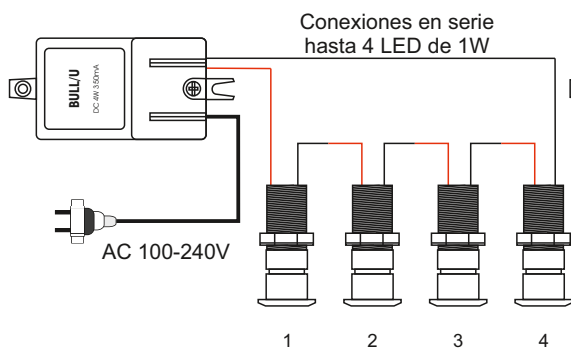

Ejemplo de instalación: BULL500

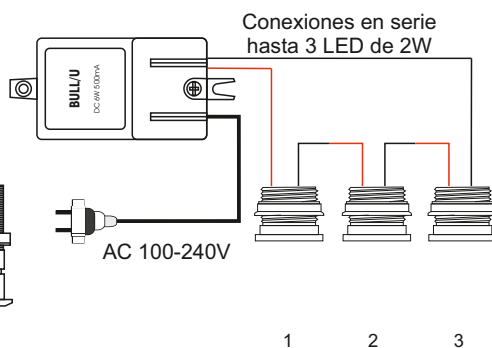

El SMART26 puede ser configurable con salida de 350mA, 500mA, 550mA y 700mA mediante un dip-switch.

Ejemplo de instalación: SMART26 configurado a 350mA

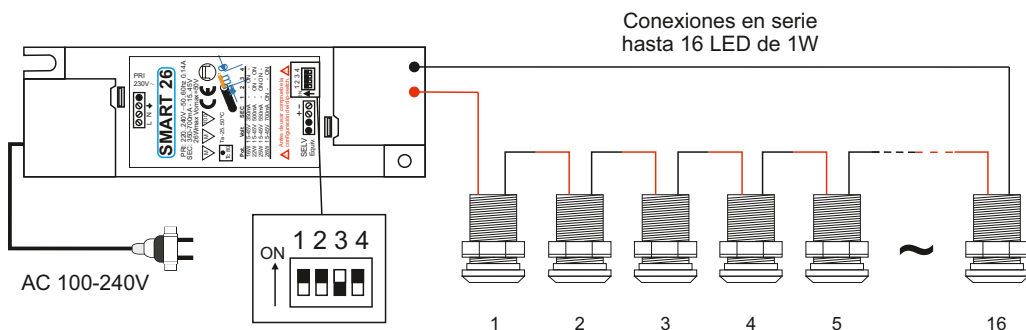

Ejemplo de instalación: SMART26 configurado a 500mA

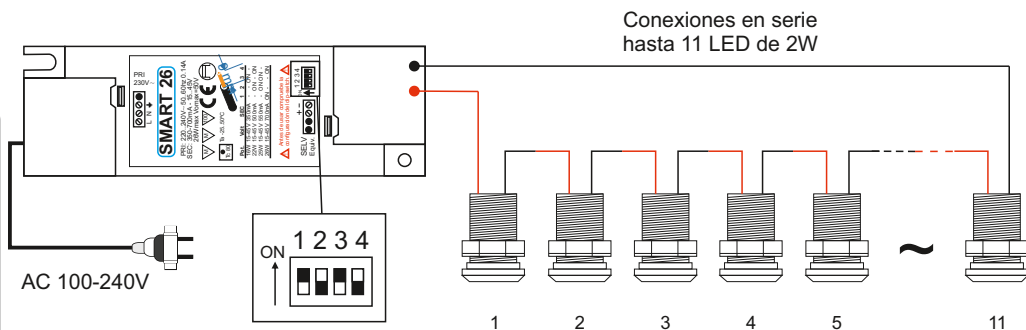

TRGBox

Ejemplo de instalación: TRGBox

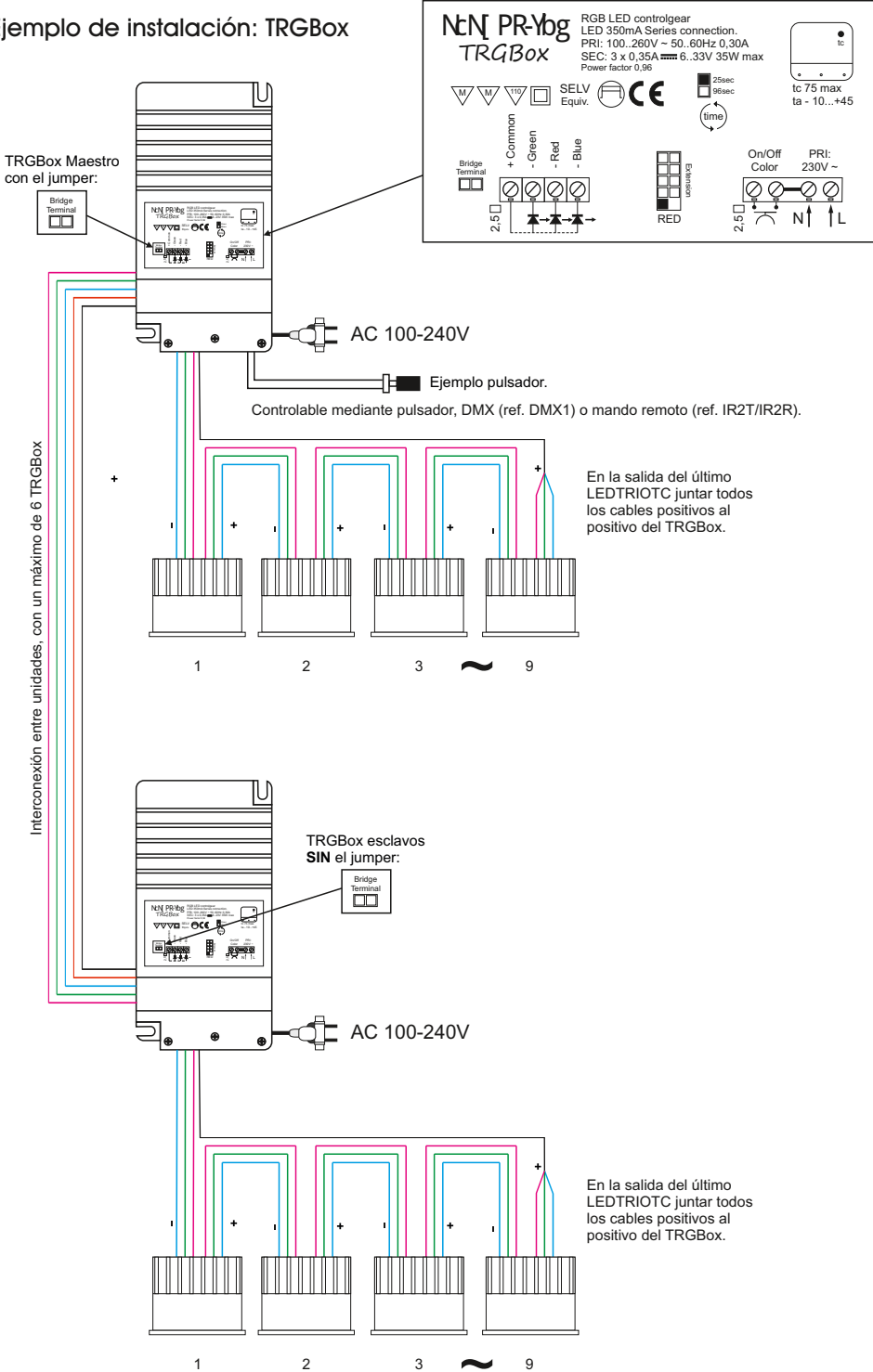

TRGBox4

Ejemplo de instalación: TRGBox4

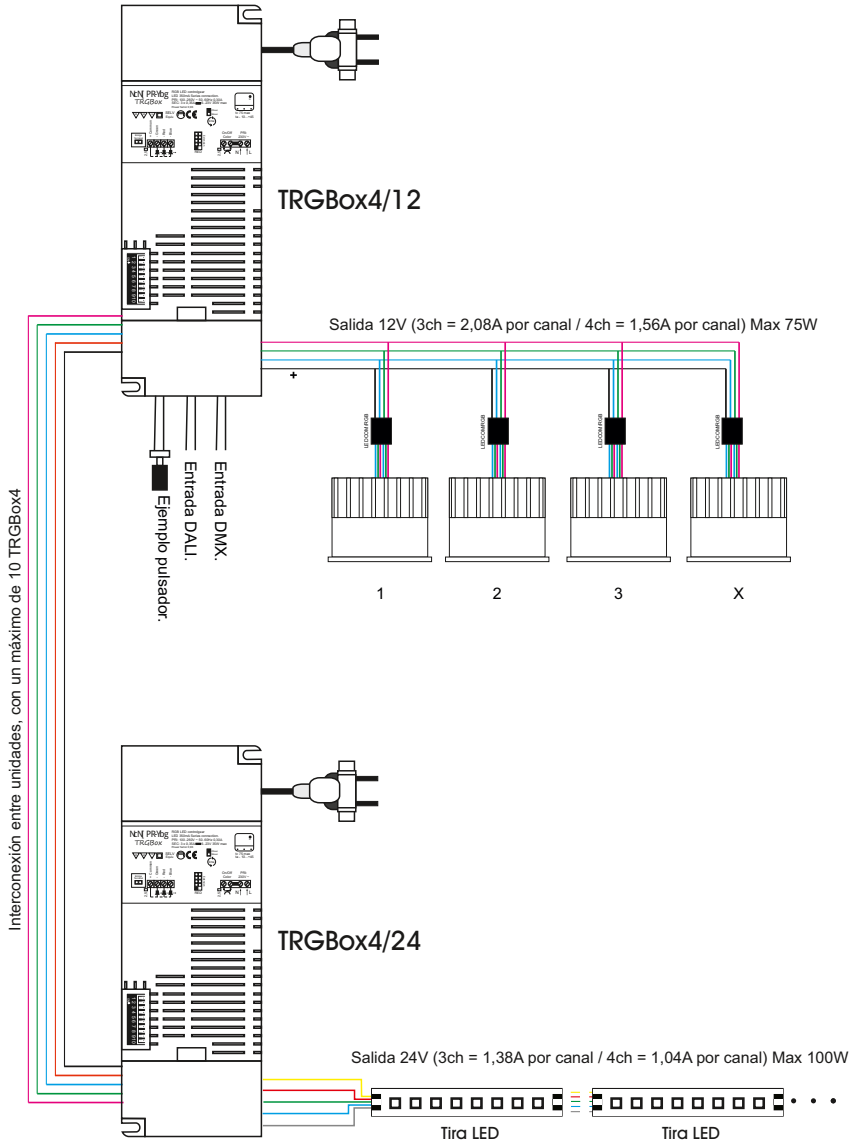

DIMMERS DALI / TRIAC

Ejemplo de instalación: AVC-DALI

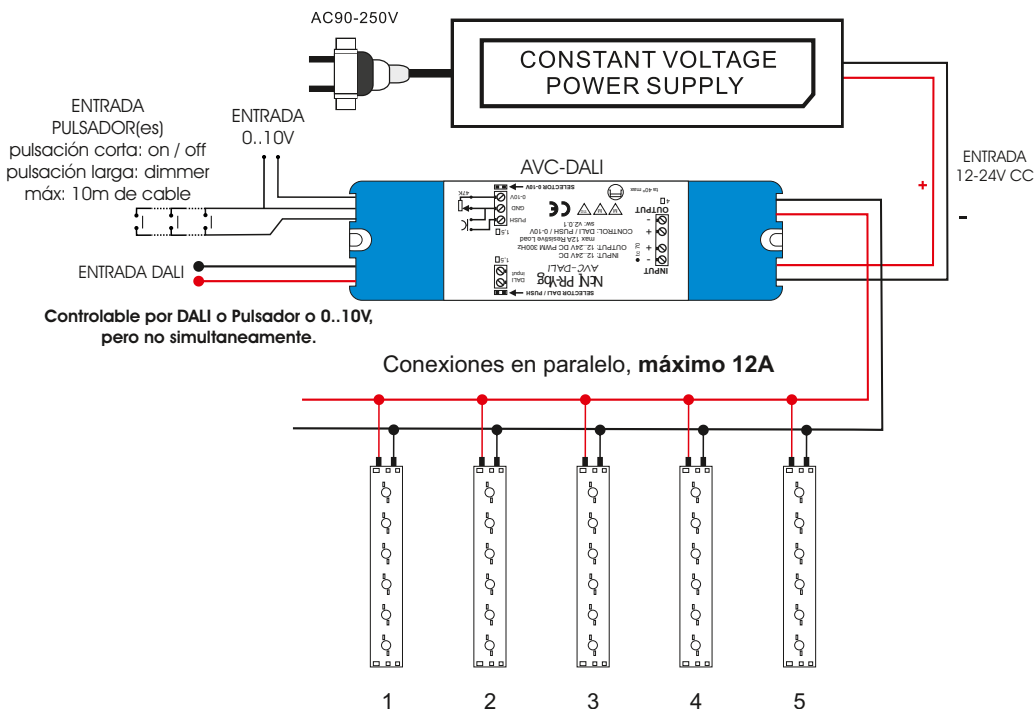

Ejemplo de instalación: AVC-DALI

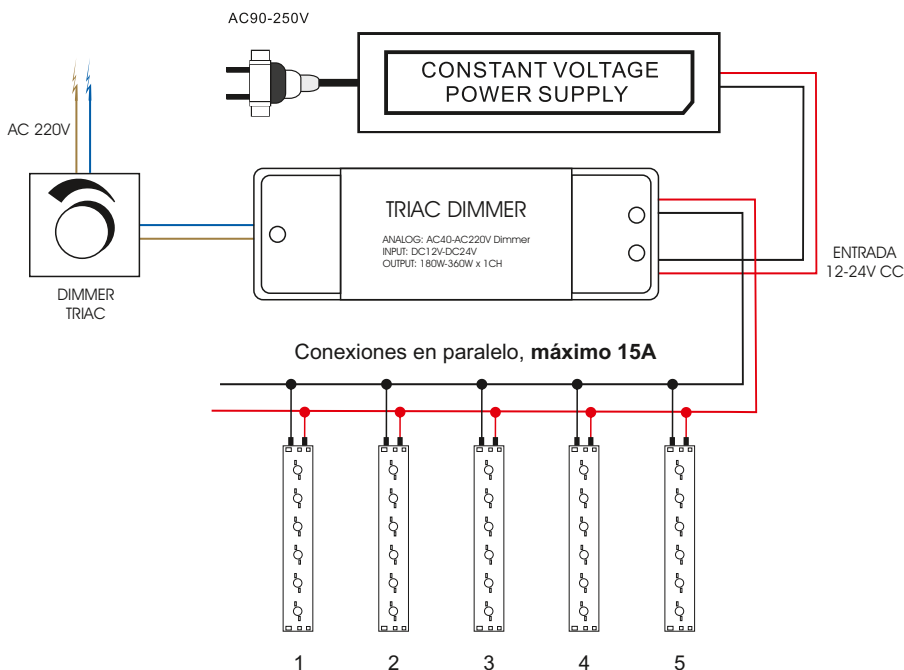

Compatibilidad serie MI

MI-RF2.1 MI-RFCTA MI-RF2.4 MI-RFRGBCTA MI-B2 / MI-T2 MI-B4 / MI-T4 MI-IBOX MI-FUTD01



MI-RF2.1



●		●	●			●	●	
---	--	---	---	--	--	---	---	--

MI-RF2.1

MI-FUT036



	●		●	●	●	●	●	
--	---	--	---	---	---	---	---	--

MI-FUT036

MI-FUT035



	●		●	●	●	●	●	
--	---	--	---	---	---	---	---	--

MI-FUT035

MI-FUT037



●		●	●			●	●	
---	--	---	---	--	--	---	---	--

MI-FUT037

MI-FUT038



●		●	●			●	●	
---	--	---	---	--	--	---	---	--

MI-RF2.4R

MI-LS4



	●			●	●	●	●	
--	---	--	--	---	---	---	---	--

MI-LS4

MI-FUT011



	●		●	●	●	●	●	
--	---	--	---	---	---	---	---	--

MI-FUT011

MI-FUT018



●		●	●			●	●	
---	--	---	---	--	--	---	---	--

MI-FUT018

MI-FUT012



●		●	●			●	●	
---	--	---	---	--	--	---	---	--

MI-FUT016

MI-FUT019



	●		●	●	●	●	●	
--	---	--	---	---	---	---	---	--

MI-FUT019

MI-FUTD02



			●			●		●
--	--	--	---	--	--	---	--	---

MI-FUTD02

MI-FUTD04



			●			●		●
--	--	--	---	--	--	---	--	---

MI-FUTD04

MI-RF2.1 MI-RFCTA MI-RF2.4 MI-RFRGBCTA MI-B2 / MI-T2 MI-B4 / MI-T4 MI-IBOX MI-FUTD01

Serie MI RF

Ejemplo de instalación: MI-FUT018 + MI-T4/MI-B4 + MI-RF2.4 + MI-IBOX

Zona 1
MI-FUT018
+
MI-RF2.4R

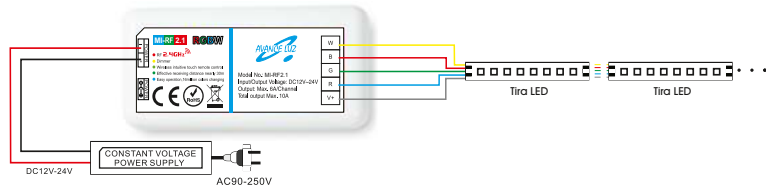
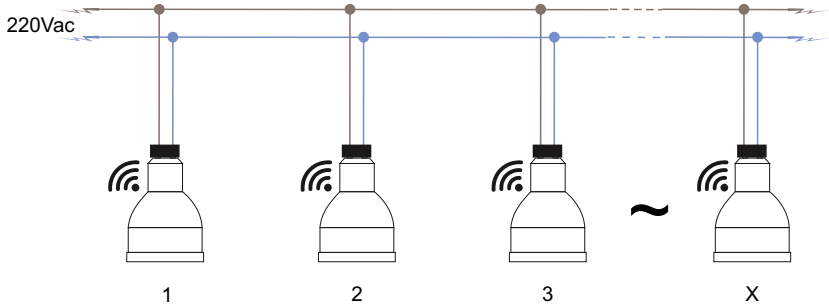

Zona 2
MI-FUT018

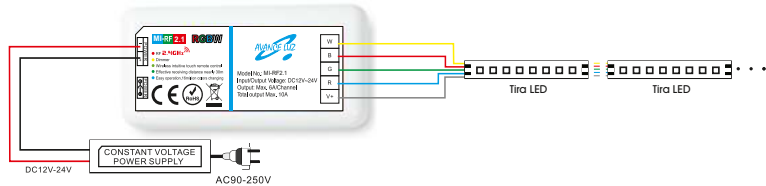
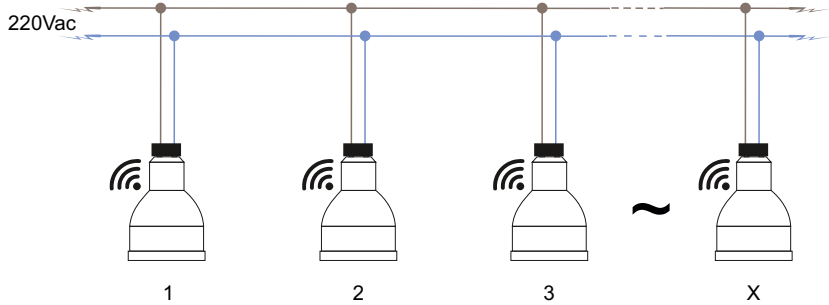

Zona 3
MI-RF2.4R

Control simultaneo mediante panel táctil, mando remoto y aplicación de SmartPhone.



ESQUEMAS

Serie MI DMX

Ejemplo de instalación: MI-FUTD01 + MI-FUTD02 + MI-FUTD03 + SLESA-U9

La antena MI-FUTD01 controla hasta 80 canales separados en grupos de 5 (16 zonas en total).

En este ejemplo vamos a configurar la antena que empiece en el canal DMX 015 como ejemplo práctico.



Puede funcionar en modo vivo mediante un PC o programandose y funcionando en modo autonomo.

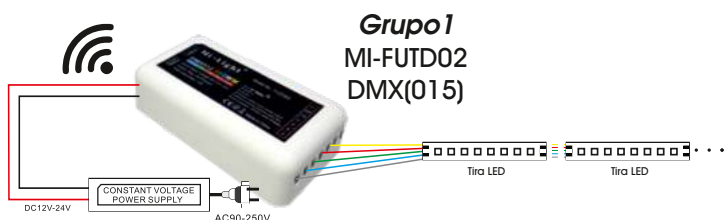

Grupo2
MI-FUTD03
DMX(020)

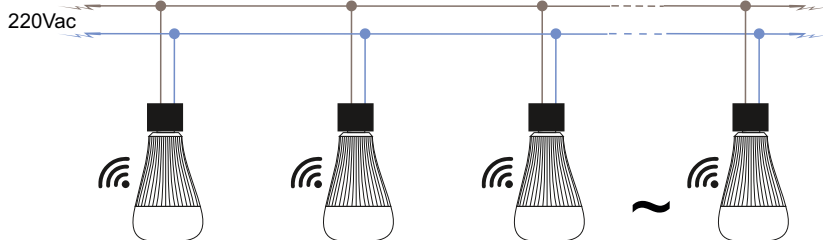
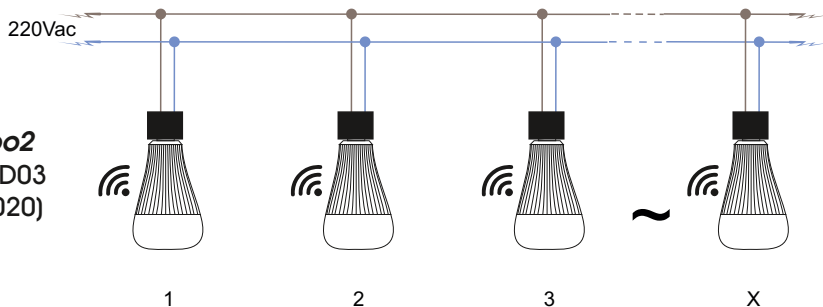

Grupo3
MI-FUTD03
DMX(025)

Grupo4
MI-FUTD03
DMX(030)

Grupo5
MI-FUTD03
DMX(035)

Grupo6
MI-FUTD03
DMX(040)

Modulos LED

Ejemplo de instalación: CMP4

Válido para todas las instalaciones de módulos monocolor.

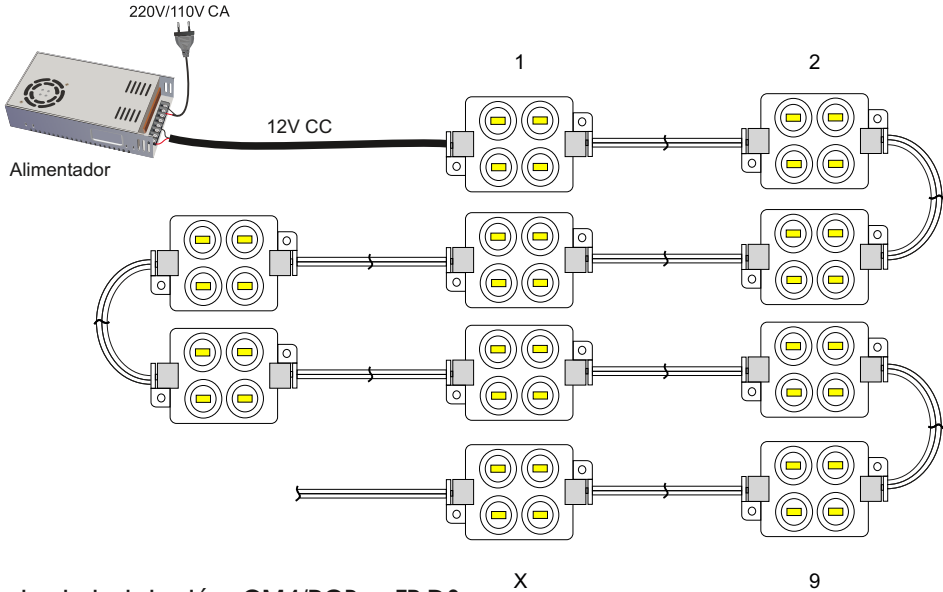

Ejemplo de instalación: CM4/RGB + TP-D3

Válido para todas las instalaciones de módulos RGB.

